

Tubo r gido

Conductions rigides

Pipe conductions

Tubo rigido



Tubería rígida

Tube rigide
Pipe
Tubo rígido

1

Racores DIN 2353

Raccords à bague DIN 2353
DIN 2353 Pipe Fittings
Raccordi ad anello DIN 2353

2

Racores para tubo gas

Raccords tube gaz
Gas tube fittings
Raccordi per tubo gas

3

Racores JIC 37°

Raccords JIC 37°
JIC 37° fittings
Raccordi JIC 37°

4

Bridas SAE

Brides de fixation SAE
SAE Flanges
Flange SAE

5

Abrazaderas

Colliers
Clamps
Collari fissatubo

6

Máquinas para procesar el tubo rígido

Machines pour travailler le tube rigide
Machines for processing rigid pipes
Macchine per il trattamento del tubo rigido

7

Tubería rígida

Tube rigide

Pipe

Tubo rigido



Tubo rígido DIN 2391 (métrico)

Tube rigide DIN 2391 (Métrique) | Pipe DIN 2391 (Metric) | Tubo rigido DIN 2391 (Metric)

118

Tubo rígido DIN 2391 (métrico)

Tube rigide DIN 2391 (Métrique) | Pipe DIN 2391 (Metric) | Tubo rigido DIN 2391 (Metrico)

Tubo ST-35 (normal) | Tube rigide ST-35 (normal) | Pipe ST-35 (normal) | Tubo rigido ST-35 (normale)



TH0



THZ

Tubo rígido DIN 2391 (métrico)

Tube rigide DIN 2391 (Métrique)

Pipe DIN 2391 (Metric)

Tubo rigido DIN 2391 (Metrico)

Tubo ST-35 (standard)



Tube rigide ST-35 (standard)

Pipe ST-35 (standard)

Tubo rigido ST-35 (standard)

Ø ext	Ø int	Pr.Tr. (bar) WP (bar)	Kg/m	REFERENCIA PART N°	€
6	4	325	0,123	TH0060100	4,06
8	6	225	0,172	TH0080100	4,76
8	5	375	0,24	TH0080150	4,94
10	7	275	0,314	TH0100150	5,53
12	9	225	0,388	TH0120150	6,12
14	10	275	0,591	TH0140200	8,70
15	12	175	0,499	TH0150150	7,18
16	12	225	0,69	TH0160200	9,41
16	11	300	0,832	TH0160250	11,41
18	14	200	0,789	TH0180200	9,47
20	14	275	1,257	TH0200300	14,59
22	18	150	0,986	TH0220200	11,94
25	19	225	1,627	TH0250300	17,94
28	24	125	1,282	TH0280200	15,76
30	24	175	1,997	TH0300300	21,29
35	29	150	2,367	TH0350300	25,64
38	28	250	4,068	TH0380500	42,82
42	36	125	2,885	TH0420300	31,23

Tubo ST-37.2 (Cromo III)



Tube rigide ST-37.2 (Chrome III)

Pipe ST-37.2 (Chromium III)

Tubo rigido ST-37.2 (Cromo III)

Ø ext	Ø int	Pr.Tr. (bar) WP (bar)	Kg/m	REFERENCIA PART N°	€
6	4	325	0,123	THZ060100	4,88
8	6	225	0,172	THZ080100	5,71
8	5	375	0,24	THZ080150	5,88
10	7	275	0,314	THZ100150	6,71
12	9	225	0,388	THZ120150	7,41
14	10	275	0,591	THZ140200	10,12
15	12	175	0,499	THZ150150	8,82
15	11	250	0,641	THZ150200	10,88
16	12	225	0,69	THZ160200	11,17
18	15	150	0,61	THZ180150	9,65
18	14	200	0,789	THZ180200	11,35
20	14	275	1,257	THZ200300	16,59
22	18	150	0,986	THZ220200	14,17
25	19	225	1,627	THZ250300	20,88
28	24	125	1,282	THZ280200	19,17
30	22	250	2,564	THZ300400	31,76
35	29	150	2,367	THZ350300	30,23
38	28	250	2,885	THZ380500	*
42	36	125	2,885	THZ420300	*

Maleabilidad: Muy buena | Malléabilité: Très bonne | Malleability: Very good | Malleabilità: Molto buona

Soldadilidad: Muy buena | Soudure: Très bonne | Welding: Very good | Soldabilità: Molto buona

Resistencia a la tracción: 35/45 kg. mm² | Résistance à la traction: 35/45 Kg. mm² | Resistant to traction: 35/45 Kg. mm² | Resistenza alla trazione: 35/45 Kg. mm²

Alargamiento: Mín. 25% | Prolongement: Min. 25% | Prolongation: Min. 25% | Allungamento: Min. 25%

Análisis | Analyse | Analysis | Analisi:

- **Carbono: Máx. 0,18%** | Carbone: Max. 0,18% | Carbon: Max. 0,18% | Carbonio: Max. 0,18%
- **Fósforo: Máx. 0,05%** | Phosphore: Máx. 0,05% | Phosphorus: Max. 0,05% | Fosforo: Max. 0,05%
- **Azufre: Máx. 0,05%** | Soufre: Max. 0,05% | Sulphur: Max. 0,05% | Zolfo: Max 0,05%

Tubos de precisión en acero sin soldadura, calibrados interior y exteriormente por estirado en frío, de acuerdo con la norma DIN-2391 y en la calidad de acero St. 35. Suministrados en acabado NBK (normalizado en horno de atmósfera controlada), probados unitariamente a presión hidráulica, o bien, por corriente de Foucault y en largos comerciales de 3 a 7 m. | Tubes de precision de circuit de soudure, en acier doux, alésage en l'intérieur et l'extérieur par être étirés à froid suivant norme DIN-2391 en la qualité d'acier St 35. Tube recuit en atmosphère neutre, parfait NBK. Tous les tubes nubiennent un contrôle systématique non destructif au courant de Foucault et un contrôle visuel sur table de l'aspect extérieur du tube. La commercialisation des tubes est en longueurs de 3 à 7 mètres. | Precision pipes in carbon steel without welding, internal and external calibration by cold stretch, according to norm DIN - 2391 and in carbon quality ST. 35. Finished in NBK (normalized in controlled atmosphere furnace). Tested to hydraulic pressure one by one, or, by Foucault current and in commercial lengths from 3 to 7 M. | Tubo di precisione in acciaio senza saldatura, calibrato internamente e esternamente, trafilato a freddo secondo normativa DIN-2391 e qualità acciaio ST-35. Ricottura in NBK (normalizzato a forno in atmosfera controllata). Testato alla pressione idraulica al 100%, a vista ed a corrente di Foucault, in verge commerciali da 3 a 7 mt.

(1) Presión de trabajo: Presión máxima de utilización recomendada, teniendo en cuenta que la presión de estallido es aproximadamente cuatro veces la presión indicada en la tabla. | (1) Presión travail: C'est la pression máx. de travail que nous conseillons, en present que la presión d'éclatement cést 4 fois la pression indiqué au tableau | (1) Working pressure: Suggested working pressure, taking in account that the burst pressure in about 4 times the indicated pressure in the table | (1) Pressione di lavoro: pressione massima di utilizzo raccomandada, tenendo in considerazione che la pressione di scoppio è circa quatro volte la pressione indicata nella tabella.

* **Consultar** | Sur demande | On request | Su richiesta

Racores DIN 2353

Raccords à bague DIN 2353

DIN 2353 Pipe Fittings

Raccordi ad anello DIN 2353



Racores DIN 2353

Raccords à bague DIN 2353 | DIN 2353 Pipe fittings | Raccordi ad anello DIN 2353

124

Racores DIN 2353

Raccords à bague DIN 2353 | DIN 2353 Pipe fittings | Raccordi DIN 2353

Pipe

DIN 2353 Pipe Fittings

Gas tube fittings

JIC 37° fittings

SAE Flanges

Clamps

Machines for processing rigid pipes

Instrucciones de montaje del racor DIN 2353 sobre el tubo rígido (se recomienda el uso de herramientas de premontaje)
 | **Instructions de montage du raccord DIN 2353 sur le tube rigide (On recommande l'utilisation des outils de pré-montage)** |
Assembly of the pipe fittings DIN 2353 in the rigid pipe (It is recommended to use pre-assembly tools) | **Assemblaggio del**
raccordo ad anello DIN 2353 nel tubo rigido (è si consiglia l'uso degli utensili di premontaggio)

A. Preparación del tubo | Préparation du tube | Preparation of the tube | Preparazione del tubo

Altura mínima (H)
 | Hauteur minimale (H) | Minimum Height (H) | Minima lunghezza diritta (H)

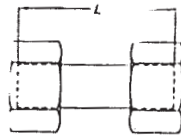
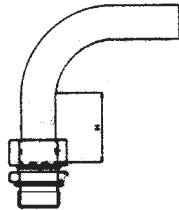

Longitud mínima (L)
 | Longueur minimale (L) | Minimum Length (L) | Minima lunghezza (L)

Series	LL	L	S
Ø ext. tube	4-5-6-8	6-8-10-12-15-18-22-28-35-42	6-8-10-12-14-16-20-25-30-38
H min	LL 24-25-25-26	L 31-31-33-33-36-38-42-42-48-48	S 35-35-37-37-43-43-50-54-58-65
L min	LL 30-32-32-33	L 39-39-42-42-45-48-53-53-60-60	S 44-44-47-47-54-54-63-68-73-82



Cortar el tubo a escuadra y eliminar rebabas | Couper le tube à angle droit sans coupes imprécises | Rectangularly saw off the pipe and slightly debug the tube ends inside and outside | Tagliare il tubo ad angolo retto ed eliminare i residui metallici

B. Lubricar adecuadamente | Lubrifier convenablement | Lubricate suitably | Lubrificare convenientemente

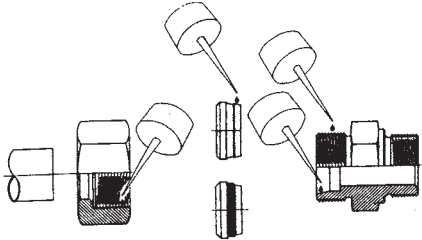

C. Montaje | Montage | Assembly | Montaggio

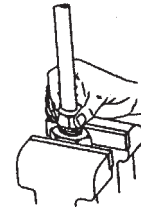

D. Apriete | Blockage | Blocking | Bloccaggio

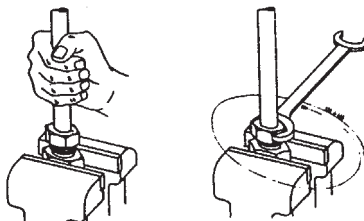

E. Control | Control | Control | Controllo



F. Montaje final | Montage final | Final assembly | Montaggio finale

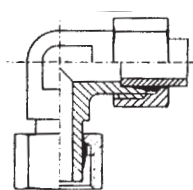

G. Montajes posteriores | Montages posterieurs | Later assemblies | Montaggio successivo

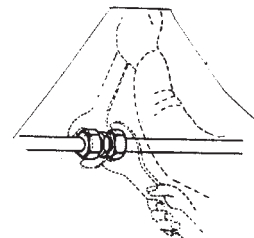

Una solución eficaz, económica y sencilla para prevenir el goteo en las conducciones de tubo rígido

Une solution efficace, économique et simple pour prévenir les fuites dans les émbouts pour tube rigide | An effective, cheap and single solution to prevent the leak in pipe fittings | Una soluzione efficace, economica e semplice per prevenire perdite dai raccordi per tubo rigido

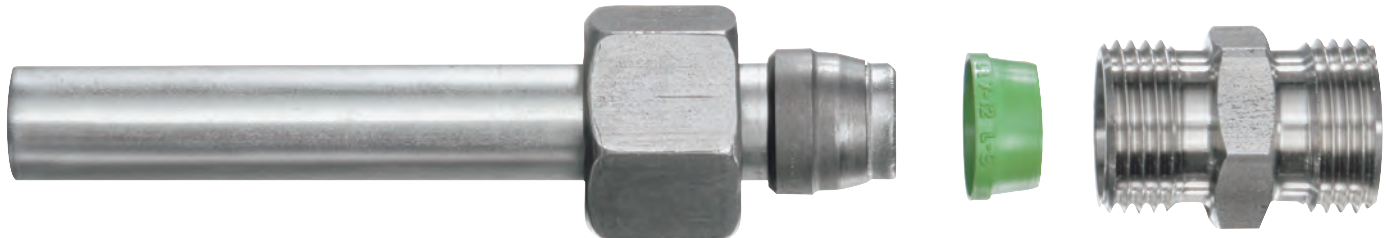

- | | | | |
|--|---|---|---|
| <ul style="list-style-type: none"> ▪ Óptima prevención de fugas ▪ Larga durabilidad ▪ Fácil montaje, revisión y sustitución ▪ Protección antivibraciones ▪ Excelente resistencia a altas temperaturas y fluidos agresivos | <ul style="list-style-type: none"> ▪ Bonne prévention de fuites ▪ Longue durée ▪ Facile montage, inspection et substitution ▪ Protection Anti-vibration ▪ Excellente résistance aux hautes températures et fluides agressifs | <ul style="list-style-type: none"> ▪ Good leakage prevention ▪ Long shelf life ▪ Easy assembly, inspection, replacement ▪ Anti-vibration and unscrewing protection ▪ Excellent resistance to high temperatures and aggressive fluids | <ul style="list-style-type: none"> ▪ Buona prevenzione delle perdite ▪ Lunga durata ▪ Facile montaggio, ispezione e sostituzione ▪ Antivibrazione e protezione allo svitamento ▪ Eccellente resistenza alle alte temperature e fluidi aggressivi |
|--|---|---|---|

Información técnica | Information technique | Technical data | Informazione tecnica

Material Matériel Material Materiale	Vitón verde Viton vert 70/80 sh Green viton 70/80 sh Viton verde
Temperatura Temperature Temperature Temperatura	-35°C + 100°C
Durabilidad Durée Self life Durata	5 años 5 an 5 year 5 anni

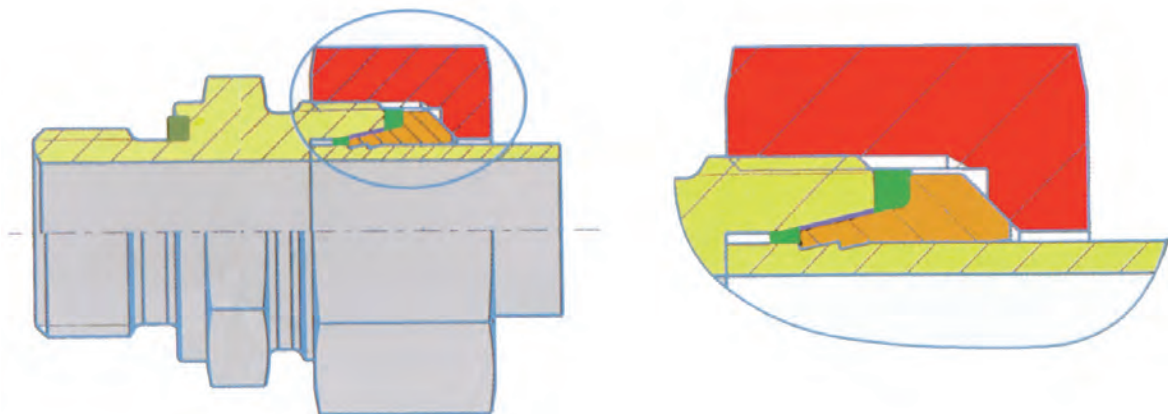

Racores DIN 2353

Raccords à bague DIN 2353 | DIN 2353 Pipe fittings | Raccordi ad anello DIN 2353

Pipe

Tuercas y anillos | Écrou et bagues | Nuts and cutting rings | Dadi e anelli

127

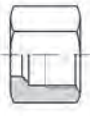

ML/MS



ACL/ACS



VA

DIN 2353 Pipe Fittings

Uniones tubo-tubo | Unions doubles | Straight couplings | Raccordi intermedi

128

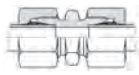

DL/DS



DL/DS

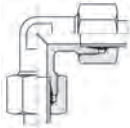

EL/ES



TL/TS



KVL/KVS

Gas tube fittings

Uniones rectas tubo-rosca | Unions simples mâle | Straight male stud couplings | Raccordi di estremità diritti

130

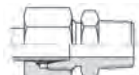

AKL/AKS BSPT



AL/AS BSP



AL/AS WD BSP



AKL/AKS NPT



AL/AS UNF



AL/AS METRICA



AL/AS WD METRICA



AKLL METRICA

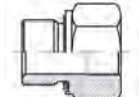

RI-R WD

JIC 37° fittings

Codos tubo-rosca | Coudes mâle gaz | Male stud elbows | Raccordi di estremità a 90°

134

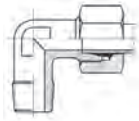

CKL/CKS BSPT

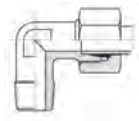

CKL/CKS METRICA

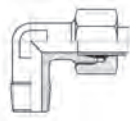

CKL/CKS NPT



STA WEE

SAE Flanges

Uniones Métricas | Unions Métriques | Metric unions | Raccordi di riduzione (Metrici)

135



KORL-TLM



KORS-TLM

Clamps

Racores regulables | Raccords réglables | Adjustable stud couplings | Raccordi orientabili

136

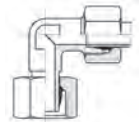

EEL/EES-CTA

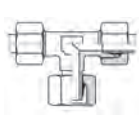

TEL/ES-CTA

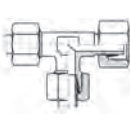

LEL/LES-CTA



EEL/EES-TLM



TEL/ES-TLM



LEL/LES-TLM

Machines for processing rigid pipes

Tubo roscado (hembra giratoria) | Tube fileté | Adjustable straight stud | Raccordi di estremità per combinazioni

137



ATL/ATS

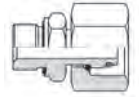

RAL/RAS-TLM WD METRICA

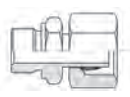

RAL/RAS-CTA WD METRICA

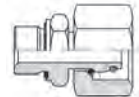

RAL/RAS-TLM WD BSP

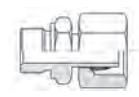

RAL/RAS-CTA WD BSP

► **Soldables** | Raccords à souder | Weld | Raccordi a saldare 139

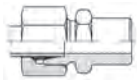

ASL/ASS



ORIL/ORIS



ESVL/ESVS

► **Pasatabiques** | Passe cloison | Bulkhead | Raccordi di attraversamento 140



SVL/SVS



USVL/USVS

► **Racor recto hembra** | Raccord droite femelle | Straight female coupling | Raccordi diritti con estremità femmina 140



GAIL/GAIS BSP



BAIL/GAIS METRICA



MAVL/MAVS BSP

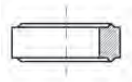

AM

► **Orientables** | Banjos | Banjos | Raccordi orientabili a occhio 141



WSVL/WSVS BSP



WSVL/WSVS METRICA

► **Tapones** | Bouchons | Plugs | Tappi 142



BUTZEN L/S



STOPFEN BSP



STOPFEN METRICA

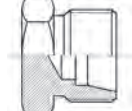

STA TML

► **Válvulas antirretorno** | Clapet antiretour pour tube | Non-return valves | Valvole di ritegno 143



RHDL/RHDS
BIDIRECCIONAL



RHVL/RHVS <=>

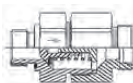

RHZL/RHVS =>

Racores DIN 2353

Raccords à bague DIN 2353
DIN 2353 Pipe fittings
Raccordi ad anello DIN 2353

Tuerca Métrica DIN 3870



Écrou Métrique DIN 3870
Nuts DIN 3870
Dadi Metrici DIN 3870

TUBO PIPE	SERIE	ROSCA THREAD	REFERENCIA PART N°	€
4	LL	M8x1	MLL 4 M 8X1	0,26
6	LL	M10x1	MLL 6 M 10X1	0,27
8	LL	M12x1	MLL 8 M 12X1	0,29
6	L	M12x1,5	ML 6 M 12X1.5	0,28
8	L	M14x1,5	ML 8 M 14X1.5	0,32
10	L	M16x1,5	ML 10 M 16X1.5	0,36
12	L	M18x1,5	ML 12 M 18X1.5	0,47
15	L	M22x1,5	ML 15 M 22X1.5	0,66
18	L	M26x1,5	ML 18 M 26X1.5	1,22
22	L	M30x2	ML 22 M 30X2	1,73
28	L	M36x2	ML 28 M 36X2	3,29
35	L	M45x2	ML 35 M 45X2	4,15
42	L	M52x2	ML 42 M 52X2	4,29
6	S	M14x1,5	MS 6 M 14X1.5	0,32
8	S	M16x1,5	MS 8 M 16X1.5	0,38
10	S	M18x1,5	MS 10 M 18X1.5	0,52
12	S	M20x1,5	MS 12 M 20X1.5	0,62
14	S	M22x1,5	MS 14 M 22X1.5	0,93
16	S	M24x1,5	MS 16 M 24X1.5	1,29
20	S	M30x2	MS 20 M 30X2	1,92
25	S	M36x2	MS 25 M 36X2	3,70
30	S	M42x2	MS 30 M 42X2	4,57
38	S	M52x2	MS 38 M 52X2	6,71

Anillos de corte DIN 3861



Bague Métrique DIN 3861
Cutting rings DIN 3861
Anelli DIN 3861

TUBO PIPE	SERIE	REFERENCIA PART N°	€
4	LL	ACLL 4	0,32
6	LL	ACLL 6	0,32
8	LL	ACLL 8	0,32
6	L/S	ACL 6	0,30
8	L/S	ACL 8	0,31
10	L/S	ACL 10	0,36
12	L/S	ACL 12	0,39
15	L	ACL 15	0,45
18	L	ACL 18	0,66
22	L	ACL 22	0,78
28	L	ACL 28	0,94
35	L	ACL 35	1,48
42	L	ACL 42	2,13
14	S	ACS 14	0,73
16	S	ACS 16	0,72
20	S	ACS 20	0,92
25	S	ACS 25	1,16
30	S	ACS 30	1,45
38	S	ACS 38	1,99

Anillo vitón antifuga



Joint viton anti-fouet
Viton seal non-leak
Anello viton anti-fuga

TUBO PIPE	SERIE	REFERENCIA PART N°	€
6	L/S	VA006L	1,15
8	L/S	VA008L	1,22
10	L/S	VA010L	1,26
12	L/S	VA012L	1,37
15	L	VA015L	1,79
18	L	VA018L	1,84
22	L	VA022L	2,06
28	L	VA028L	2,84
35	L	VA035L	4,49
42	L	VA042L	5,40
14	S	VA014S	1,49
16	S	VA016S	1,81
20	S	VA020S	1,99
25	S	VA025S	2,69
30	S	VA030S	4,12
38	S	VA038S	5,31

Racores DIN 2353

Raccords à bague DIN 2353
DIN 2353 Pipe fittings
Raccordi ad anello DIN 2353

Pipe

Unión recta tubo-tubo



Union double

Straight coupling

Raccordo intermedio diritto

TUBO PIPE	SERIE	REF. PART N°	€	REFERENCIA STA PART N° STA	€
4	LL	DLL 4	2,10	STA DLL 4	0,87
6	LL	DLL 6	2,33	STA DLL 6	1,05
8	LL	DLL 8	2,37	STA DLL 8	1,06
6	L	DL 6	2,05	STA DL 6	0,72
8	L	DL 8	2,22	STA DL 8	0,85
10	L	DL 10	2,60	STA DL 10	1,01
12	L	DL 12	3,11	STA DL 12	1,10
15	L	DL 15	4,33	STA DL 15	1,59
18	L	DL 18	6,63	STA DL 18	2,09
22	L	DL 22	9,10	STA DL 22	3,42
28	L	DL 28	16,35	STA DL 28	6,63
35	L	DL 35	22,46	STA DL 35	10,37
42	L	DL 42	28,89	STA DL 42	17,14
6	S	DS 6	2,48	STA DS 6	1,10
8	S	DS 8	2,76	STA DS 8	1,28
10	S	DS 10	3,37	STA DS 10	1,46
12	S	DS 12	3,82	STA DS 12	1,56
14	S	DS 14	7,11	STA DS 14	3,50
16	S	DS 16	7,21	STA DS 16	2,37
20	S	DS 20	10,62	STA DS 20	4,41
25	S	DS 25	17,93	STA DS 25	6,92
30	S	DS 30	24,95	STA DS 30	11,57
38	S	DS 38	33,84	STA DS 38	14,74

Unión recta en reducción tubo-tubo



Union double en reduction

Straight reducing coupling

Raccordo intermedio di riduzione

TUBO PIPE	S.	REFERENCIA PART N°	€	REFERENCIA STA PART N° STA	€
8	6	L DL 8-6	4,22	STA DL 8-6	2,87
10	6	L DL 10-6	4,63	STA DL 10-6	3,19
10	8	L DL 10-8	4,78	STA DL 10-8	3,28
12	8	L DL 12-8	5,36	STA DL 12-8	3,68
12	10	L DL 12-10	5,51	STA DL 12-10	3,75
15	10	L DL 15-10	6,86	STA DL 15-10	4,77
15	12	L DL 15-12	7,04	STA DL 15-12	4,78
18	12	L DL 18-12	9,61	STA DL 18-12	6,48
18	15	L DL 18-15	10,05	STA DL 18-15	6,61
22	15	L DL 22-15	12,58	STA DL 22-15	8,38
22	18	L DL 22-18	13,54	STA DL 22-18	8,50
28	22	L DL 28-22	25,78	STA DL 28-22	17,90
35	22	L DL 35-22	33,91	STA DL 35-22	24,43
35	28	L DL 35-28	36,58	STA DL 35-28	25,07
42	35	L DL 42-35	52,53	STA DL 42-35	38,40
8	6	S DS 8-6	5,90	STA DS 8-6	4,44
10	6	S DS 10-6	8,76	STA DS 10-6	7,33
10	8	S DS 10-8	7,43	STA DS 10-8	5,71
12	6	S DS 12-6	7,58	STA DS 12-6	5,75
12	8	S DS 12-8	7,61	STA DS 12-8	5,73
12	10	S DS 12-10	7,91	STA DS 12-10	5,81
14	10	S DS 14-10	14,48	STA DS 14-10	11,63
14	12	S DS 14-12	14,23	STA DS 14-12	11,24
16	12	S DS 16-12	10,43	STA DS 16-12	7,06
16	14	S DS 16-14	14,97	STA DS 16-14	10,85
20	12	S DS 20-12	14,65	STA DS 20-12	11,86
20	16	S DS 20-16	15,20	STA DS 20-16	9,70
25	16	S DS 25-16	27,30	STA DS 25-16	19,42
25	20	S DS 25-20	26,99	STA DS 25-20	18,15
30	20	S DS 30-20	36,27	STA DS 30-20	25,95
30	25	S DS 30-25	38,66	STA DS 30-25	26,04
38	30	S DS 38-30	54,21	STA DS 38-30	37,30

DIN 2353 Pipe Fittings

Gas tube fittings

JIC 37° fittings

SAE Flanges

Clamps

Machines for processing rigid pipes

Racores DIN 2353

Raccords à bague DIN 2353
DIN 2353 Pipe fittings
Raccordi ad anello DIN 2353

Unión en codo tubo-tubo



Coude égal

Equal elbow coupling
Raccordo intermedio a 90°

TUBO PIPE	SERIE	REF. PART N°	€	REFERENCIA STA PART N° STA	€
4	LL	ELL 4	4,75	STA ELL 4	3,51
6	LL	ELL 6	4,79	STA ELL 6	3,51
8	LL	ELL 8	5,23	STA ELL 8	3,91
6	L	EL 6	4,75	STA EL 6	3,20
8	L	EL 8	5,00	STA EL 8	3,37
10	L	EL 10	5,34	STA EL 10	3,26
12	L	EL 12	5,67	STA EL 12	3,71
15	L	EL 15	8,54	STA EL 15	4,66
18	L	EL 18	11,65	STA EL 18	6,48
22	L	EL 22	16,32	STA EL 22	9,01
28	L	EL 28	25,98	STA EL 28	15,91
35	L	EL 35	37,55	STA EL 35	24,62
42	L	EL 42	49,33	STA EL 42	34,44
6	S	ES 6	5,45	STA ES 6	4,03
8	S	ES 8	5,79	STA ES 8	4,28
10	S	ES 10	6,76	STA ES 10	4,81
12	S	ES 12	7,61	STA ES 12	4,58
14	S	ES 14	12,95	STA ES 14	7,40
16	S	ES 16	12,06	STA ES 16	6,56
20	S	ES 20	16,59	STA ES 20	9,19
25	S	ES 25	27,47	STA ES 25	15,50
30	S	ES 30	39,01	STA ES 30	24,85
38	S	ES 38	54,78	STA ES 38	35,29

Unión en te tubo-tubo



Té égal

Equal Tee
Raccordo intermedio a T

TUBO PIPE	SERIE	REF. PART N°	€	REFERENCIA STA PART N° STA	€
4	LL	TLL 4	5,88	STA TLL 4	4,04
6	LL	TLL 6	5,94	STA TLL 6	4,04
8	LL	TLL 8	6,89	STA TLL 8	4,90
6	L	TL 6	6,11	STA TL 6	3,68
8	L	TL 8	6,60	STA TL 8	4,00
10	L	TL 10	6,70	STA TL 10	4,33
12	L	TL 12	8,79	STA TL 12	5,12
15	L	TL 15	11,55	STA TL 15	5,82
18	L	TL 18	16,00	STA TL 18	9,26
22	L	TL 22	22,63	STA TL 22	12,85
28	L	TL 28	36,77	STA TL 28	21,61
35	L	TL 35	49,62	STA TL 35	30,27
42	L	TL 42	70,06	STA TL 42	47,77
6	S	TS 6	7,12	STA TS 6	5,00
8	S	TS 8	7,80	STA TS 8	5,53
10	S	TS 10	9,01	STA TS 10	6,09
12	S	TS 12	9,87	STA TS 12	5,96
14	S	TS 14	17,76	STA TS 14	10,71
16	S	TS 16	16,50	STA TS 16	9,87
20	S	TS 20	25,90	STA TS 20	14,74
25	S	TS 25	39,10	STA TS 25	22,41
30	S	TS 30	50,75	STA TS 30	30,56
38	S	TS 38	75,66	STA TS 38	46,49

Unión en cruz tubo-tubo



Croix égale

Equal cross
Raccordo intermedio a croce

TUBO PIPE	SERIE	REF. PART N°	€	REFERENCIA STA PART N° STA	€
4	LL	KVLL 4	29,96	STA KVLL 4	26,71
6	LL	KVLL 6	29,61	STA KVLL 6	26,26
8	LL	KVLL 8	26,90	STA KVLL 8	23,87
6	L	KVL 6	21,46	STA KVL 6	18,54
10	L	KVL 10	25,56	STA KVL 10	21,98
12	L	KVL 12	28,30	STA KVL 12	23,97
18	L	KVL 18	43,44	STA KVL 18	33,70
22	L	KVL 22	71,35	STA KVL 22	70,38
28	L	KVL 28	83,35	STA KVL 28	61,06
35	L	KVL 35	114,19	STA KVL 35	84,68
42	L	KVL 42	175,65	STA KVL 42	141,85
6	S	KVS 6	25,70	STA KVS 6	22,56
8	S	KVS 8	27,92	STA KVS 8	24,55
10	S	KVS 10	30,11	STA KVS 10	25,78
12	S	KVS 12	31,94	STA KVS 12	26,94
14	S	KVS 14	47,57	STA KVS 14	39,25
16	S	KVS 16	46,60	STA KVS 16	36,37
20	S	KVS 20	66,97	STA KVS 20	60,41
25	S	KVS 25	83,43	STA KVS 25	58,21
30	S	KVS 30	112,68	STA KVS 30	80,96
38	S	KVS 38	178,21	STA KVS 38	133,72

Racores DIN 2353

Raccords à bague DIN 2353

DIN 2353 Pipe fittings

Raccordi ad anello DIN 2353

Pipe

DIN 2353 Pipe Fittings

Gas tube fittings

JIC 37° fittings

SAE Flanges

Clamps

Machines for processing rigid pipes

Racor recto rosca cónica BSPT



Union simple mâle conique

Straight male stud coupling BSPT tapered

Raccordo di estremità diritto conico BSPT

T. P.	S.	ROSCA THREAD	REFERENCIA PART N°	€	REFERENCIA STA PART N° STA	€
4	LL	1/8" BSPT	AKLL 4 R 1/8	1,38	STA AKLL 4 R 1/8	0,71
6	LL	1/8" BSPT	AKLL 6 R 1/8	1,45	STA AKLL 6 R 1/8	0,74
8	LL	1/8" BSPT	AKLL 8 R 1/8	1,59	STA AKLL 8 R 1/8	0,88
8	LL	1/4" BSPT	AKLL 8 R 1/4	1,87	STA AKLL 8 R 1/4	1,16
6	L	1/8" BSPT	AKL 6 R 1/8	1,57	STA AKL 6 R 1/8	0,88
6	L	1/4" BSPT	AKL 6 R 1/4	2,05	STA AKL 6 R 1/4	1,35
8	L	1/4" BSPT	AKL 8 R 1/4	2,23	STA AKL 8 R 1/4	1,47
10	L	1/4" BSPT	AKL 10 R 1/4	2,49	STA AKL 10 R 1/4	1,63
10	L	3/8" BSPT	AKL 10 R 3/8	2,84	STA AKL 10 R 3/8	2,00
12	L	1/4" BSPT	AKL 12 R 1/4	2,85	STA AKL 12 R 1/4	1,82
12	L	3/8" BSPT	AKL 12 R 3/8	2,71	STA AKL 12 R 3/8	1,67
12	L	1/2" BSPT	AKL 12 R 1/2	3,38	STA AKL 12 R 1/2	2,34
15	L	3/8" BSPT	AKL 15 R 3/8	8,07	STA AKL 15 R 3/8	6,84
15	L	1/2" BSPT	AKL 15 R 1/2	3,92	STA AKL 15 R 1/2	2,54
18	L	1/2" BSPT	AKL 18 R 1/2	5,06	STA AKL 18 R 1/2	2,75
22	L	3/4" BSPT	AKL 22 R 3/4	7,27	STA AKL 22 R 3/4	4,13
6	S	1/4" BSPT	AKS 6 R 1/4	2,52	STA AKS 6 R 1/4	1,76
8	S	1/4" BSPT	AKS 8 R 1/4	2,71	STA AKS 8 R 1/4	1,91
10	S	3/8" BSPT	AKS 10 R 3/8	3,38	STA AKS 10 R 3/8	2,33
12	S	3/8" BSPT	AKS 12 R 3/8	3,96	STA AKS 12 R 3/8	2,76
16	S	1/2" BSPT	AKS 16 R 1/2	6,09	STA AKS 16 R 1/2	3,65
20	S	3/4" BSPT	AKS 20 R 3/4	9,19	STA AKS 20 R 3/4	5,70

Racor recto rosca cilíndrica BSP

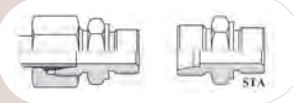

Union simple mâle gaz cyl

Straight male stud coupling BSP cyl

Raccordo di estremità diritto BSP

T. P.	S.	ROSCA THREAD	REFERENCIA PART N°	€	REFERENCIA STA PART N° STA	€
6	L	1/8" BSP	AL 6 R 1/8	1,35	STA AL 6 R 1/8	0,69
6	L	1/4" BSP	AL 6 R 1/4	1,96	STA AL 6 R 1/4	1,09
6	L	3/8" BSP	AL 6 R 3/8	2,68	STA AL 6 R 3/8	2,05
6	L	1/2" BSP	AL 6 R 1/2	9,79	STA AL 6 R 1/2	9,14
8	L	1/8" BSP	AL 8 R 1/8	2,78	STA AL 8 R 1/8	2,07
8	L	1/4" BSP	AL 8 R 1/4	1,70	STA AL 8 R 1/4	0,99
8	L	3/8" BSP	AL 8 R 3/8	2,46	STA AL 8 R 3/8	1,48
8	L	1/2" BSP	AL 8 R 1/2	5,21	STA AL 8 R 1/2	4,51
10	L	1/8" BSP	AL 10 R 1/8	4,26	STA AL 10 R 1/8	4,22
10	L	1/4" BSP	AL 10 R 1/4	1,82	STA AL 10 R 1/4	0,98
10	L	3/8" BSP	AL 10 R 3/8	2,19	STA AL 10 R 3/8	1,52
10	L	1/2" BSP	AL 10 R 1/2	3,86	STA AL 10 R 1/2	2,45
12	L	1/4" BSP	AL 12 R 1/4	2,62	STA AL 12 R 1/4	1,55
12	L	1/2" BSP	AL 12 R 1/2	3,53	STA AL 12 R 1/2	2,34
12	L	3/4" BSP	AL 12 R 3/4	7,29	STA AL 12 R 3/4	7,57
12	L	3/8" BSP	AL 12 R 3/8	2,42	STA AL 12 R 3/8	1,44
15	L	3/8" BSP	AL 15 R 3/8	4,14	STA AL 15 R 3/8	2,34
15	L	1/2" BSP	AL 15 R 1/2	3,36	STA AL 15 R 1/2	2,05
15	L	3/4" BSP	AL 15 R 3/4	12,21	STA AL 15 R 3/4	10,95
18	L	1/2" BSP	AL 18 R 1/2	4,30	STA AL 18 R 1/2	2,03
18	L	3/4" BSP	AL 18 R 3/4	8,04	STA AL 18 R 3/4	7,05
18	L	3/8" BSP	AL 18 R 3/8	8,96	STA AL 18 R 3/8	8,15
22	L	1/2" BSP	AL 22 R 1/2	11,06	STA AL 22 R 1/2	6,04
22	L	3/4" BSP	AL 22 R 3/4	6,33	STA AL 22 R 3/4	3,29
22	L	1" BSP	AL 22 R 1	26,84	STA AL 22 R 1	28,64
28	L	3/4" BSP	AL 28 R 3/4	26,15	STA AL 28 R 3/4	21,26
28	L	1" BSP	AL 28 R 1	11,65	STA AL 28 R 1	6,56
35	L	1" BSP	AL 35 R 1	33,53	STA AL 35 R 1	26,54
35	L	1"1/4 BSP	AL 35 R 1 1/4	16,72	STA AL 35 R 1 1/4	10,21
42	L	1"1/2 BSP	AL 42 R 1 1/2	19,92	STA AL 42 R 1 1/2	12,44
6	S	1/4" BSP	AS 6 R 1/4	1,83	STA AS 6 R 1/4	1,14
8	S	1/4" BSP	AS 8 R 1/4	2,01	STA AS 8 R 1/4	1,16
8	S	3/8" BSP	AS 8 R 3/8	4,95	STA AS 8 R 3/8	4,21
10	S	1/4" BSP	AS 10 R 1/4	3,77	STA AS 10 R 1/4	2,82
10	S	3/8" BSP	AS 10 R 3/8	2,64	STA AS 10 R 3/8	1,68
10	S	1/2" BSP	AS 10 R 1/2	4,07	STA AS 10 R 1/2	3,12
12	S	1/4" BSP	AS 12 R 1/4	4,99	STA AS 12 R 1/4	3,88
12	S	3/8" BSP	AS 12 R 3/8	2,88	STA AS 12 R 3/8	1,62
12	S	1/2" BSP	AS 12 R 1/2	3,45	STA AS 12 R 1/2	2,17
14	S	3/8" BSP	AS 14 R 3/8	15,66	STA AS 14 R 3/8	13,86
14	S	1/2" BSP	AS 14 R 1/2	5,02	STA AS 14 R 1/2	3,22
16	S	3/8" BSP	AS 16 R 3/8	9,87	sta AS 16 R 3/8	7,64
16	S	1/2" BSP	AS 16 R 1/2	4,76	STA AS 16 R 1/2	2,31
16	S	3/4" BSP	AS 16 R 3/4	7,99	STA AS 16 R 3/4	5,74
20	S	1/2" BSP	AS 20 R 1/2	12,58	STA AS 20 R 1/2	9,35
20	S	3/4" BSP	AS 20 R 3/4	7,33	STA AS 20 R 3/4	4,00
25	S	3/4" BSP	AS 25 R 3/4	19,30	STA AS 25 R 3/4	10,88
25	S	1" BSP	AS 25 R 1	12,81	STA AS 25 R 1	6,92
30	S	1" BSP	AS 30 R 1	24,13	STA AS 30 R 1	14,92
30	S	1"1/4 BSP	AS 30 R 1 1/4	19,64	STA AS 30 R 1 1/4	12,63
38	S	1"1/4 BSP	AS 38 R 1 1/4	27,99	STA AS 38 R 1 1/4	18,28
38	S	1"1/2 BSP	AS 38 R 1 1/2	24,19	STA AS 38 R 1 1/2	14,35

Racores DIN 2353

Raccords à bague DIN 2353
DIN 2353 Pipe fittings
Raccordi ad anello DIN 2353

Racor recto rosca cilíndrica BSP con junta



Union simple mâle gaz cyl avec o'ring

Straight male stud coupling with captive seal BSP cyl

Raccordo di estremità diritto BSP con o'ring

T. P.	S.	ROSCA THREAD	REFERENCIA PART N°	€	REFERENCIA STA PART N° STA	€
6	L	1/4" BSP	AL 6 R 1/4 WD	2,37	STA AL 6 R 1/4 WD	1,73
6	L	1/8" BSP	AL 6 R 1/8 WD	1,71	STA AL 6 R 1/8 WD	1,27
8	L	1/4" BSP	AL 8 R 1/4 WD	2,17	STA AL 8 R 1/4 WD	1,29
8	L	1/8" BSP	AL 8 R 1/8 WD	3,07	STA AL 8 R 1/8 WD	2,36
8	L	3/8" BSP	AL 8 R 3/8 WD	2,88	STA AL 8 R 3/8 WD	2,16
10	L	1/2" BSP	AL 10 R 1/2 WD	4,35	STA AL 10 R 1/2 WD	2,93
10	L	1/4" BSP	AL 10 R 1/4 WD	2,26	STA AL 10 R 1/4 WD	1,16
10	L	3/8" BSP	AL 10 R 3/8 WD	2,83	STA AL 10 R 3/8 WD	1,74
12	L	1/2" BSP	AL 12 R 1/2 WD	4,04	STA AL 12 R 1/2 WD	2,63
12	L	1/4" BSP	AL 12 R 1/4 WD	3,04	STA AL 12 R 1/4 WD	1,87
12	L	3/8" BSP	AL 12 R 3/8 WD	2,83	STA AL 12 R 3/8 WD	1,65
15	L	1/2" BSP	AL 15 R 1/2 WD	3,87	STA AL 15 R 1/2 WD	2,34
15	L	3/8" BSP	AL 15 R 3/8 WD	4,53	STA AL 15 R 3/8 WD	2,79
18	L	1/2" BSP	AL 18 R 1/2 WD	4,79	STA AL 18 R 1/2 WD	2,27
18	L	3/4" BSP	AL 18 R 3/4 WD	8,46	STA AL 18 R 3/4 WD	4,70
22	L	3/4" BSP	AL 22 R 3/4 WD	6,82	STA AL 22 R 3/4 WD	3,56
28	L	1" BSP	AL 28 R 1 WD	12,49	STA AL 28 R 1 WD	7,04
42	L	1 1/2" BSP	AL 42 R 1 1/2 WD	21,20	STA AL 42 R 1 1/2 WD	13,87
6	S	1/4" BSP	AS 6 R 1/4 WD	2,26	STA AS 6 R 1/4 WD	1,57
8	S	1/4" BSP	AS 8 R 1/4 WD	2,45	STA AS 8 R 1/4 WD	1,69
8	S	3/8" BSP	AS 8 R 3/8 WD	5,27	STA AS 8 R 3/8 WD	4,51
10	S	1/2" BSP	AS 10 R 1/2 WD	4,56	STA AS 10 R 1/2 WD	3,58
10	S	3/8" BSP	AS 10 R 3/8 WD	3,05	STA AS 10 R 3/8 WD	2,10
12	S	1/2" BSP	AS 12 R 1/2 WD	3,97	STA AS 12 R 1/2 WD	2,84
12	S	1/4" BSP	AS 12 R 1/4 WD	5,33	STA AS 12 R 1/4 WD	4,20
12	S	3/8" BSP	AS 12 R 3/8 WD	3,29	STA AS 12 R 3/8 WD	2,18
14	S	1/2" BSP	AS 14 R 1/2 WD	5,51	STA AS 14 R 1/2 WD	3,28
16	S	1/2" BSP	AS 16 R 1/2 WD	5,26	STA AS 16 R 1/2 WD	2,74
16	S	3/4" BSP	AS 16 R 3/4 WD	8,41	STA AS 16 R 3/4 WD	6,13
16	S	3/8" BSP	AS 16 R 3/8 WD	10,10	STA AS 16 R 3/8 WD	7,80
20	S	3/4" BSP	AS 20 R 3/4 WD	7,80	STA AS 20 R 3/4 WD	4,29
25	S	1" BSP	AS 25 R 1 WD	13,66	STA AS 25 R 1 WD	7,95
25	S	3/4" BSP	AS 25 R 3/4 WD	19,44	STA AS 25 R 3/4 WD	13,82
30	S	1 1/4" BSP	AS 30 R 1 1/4 WD	20,64	STA AS 30 R 1 1/4 WD	13,36
38	S	1 1/2" BSP	AS 38 R 1 1/2 WD	25,80	STA AS 38 R 1 1/2 WD	15,67

Racor recto rosca cónica NPT

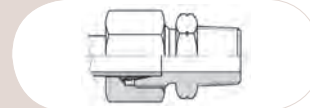

Union simple mâle NPT

Straight male stud coupling NPT

Raccordo di estremità diritto NPT conico

TUBO PIPE	SERIE	ROSCA THREAD	REFERENCIA PART N°	€
4	LL	1/8" NPT	AKLL 4 1/8 NPT	2,10
6	LL	1/8" NPT	AKLL 6 1/8 NPT	2,06
8	LL	1/8" NPT	AKLL 8 1/8 NPT	2,32
6	L	1/8" NPT	AKL 6 1/8 NPT	1,57
6	L	1/4" NPT	AKL 6 1/4 NPT	2,05
8	L	1/4" NPT	AKL 8 1/4 NPT	2,23
10	L	1/4" NPT	AKL 10 1/4 NPT	2,49
10	L	3/8" NPT	AKL 10 3/8 NPT	2,84
12	L	1/4" NPT	AKL 12 1/4 NPT	2,85
12	L	3/8" NPT	AKL 12 3/8 NPT	2,71
12	L	1/2" NPT	AKL 12 1/2 NPT	3,38
15	L	1/2" NPT	AKL 15 1/2 NPT	3,92
18	L	1/2" NPT	AKL 18 1/2 NPT	5,06
22	L	3/4" NPT	AKL 22 3/4 NPT	7,27
28	L	1" NPT	AKL 28 1 NPT	14,01
35	L	1 1/4" NPT	AKL 35 1 1/4 NPT	22,21
6	S	1/4" NPT	AKS 6 1/4 NPT	2,52
8	S	1/4" NPT	AKS 8 1/4 NPT	2,71
10	S	1/4" NPT	AKS 10 1/4 NPT	3,15
10	S	3/8" NPT	AKS 10 3/8 NPT	3,38
12	S	3/8" NPT	AKS 12 3/8 NPT	3,96
12	S	1/2" NPT	AKS 12 1/2 NPT	4,09
14	S	1/2" NPT	AKS 14 1/2 NPT	5,74
16	S	1/2" NPT	AKS 16 1/2 NPT	6,09
20	S	3/4" NPT	AKS 20 3/4 NPT	9,19
25	S	1" NPT	AKS 25 1 NPT	15,58
30	S	1 1/4" NPT	AKS 30 1 1/4 NPT	23,65

Racores DIN 2353

Raccords à bague DIN 2353
DIN 2353 Pipe fittings
Raccordi ad anello DIN 2353

Pipe

DIN 2353 Pipe Fittings

Gas tube fittings

JIC 37° fittings

SAE Flanges

Clamps

Machines for processing rigid pipes

Racor recto rosca cilíndrica UNF

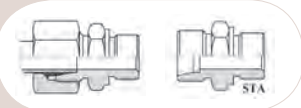

Union simple mâle UNF

Straight male stud coupling UNF

Raccordo di estremità diritto UNF

T. P.	S.	ROSCA THREAD	REFERENCIA PART N°	€	REFERENCIA STA PART N° STA	€
8	L	7/16 UNF	AL 8 7/16 UNF	12,42	STA AL 8 7/16 UNF	11,63
10	L	7/16 UNF	AL 10 7/16 UNF	12,68	STA AL 10 7/16 UNF	11,77
12	L	9/16 UNF	AL 12 9/16 UNF	13,08	STA AL 12 9/16 UNF	11,99
12	L	3/4 UNF	AL 12 3/4 UNF	15,89	STA AL 12 3/4 UNF	14,81
12	L	7/8 UNF	AL 12 7/8 UNF	17,91	STA AL 12 7/8 UNF	16,81
15	L	3/4 UNF	AL 15 3/4 UNF	16,47	STA AL 15 3/4 UNF	15,02
15	L	7/8" UNF	AL 15 7/8 UNF	19,03	STA AL 15 7/8 UNF	17,59
18	L	3/4 UNF	AL 18 3/4 UNF	19,22	STA AL 18 3/4 UNF	16,77
18	L	7/8 UNF	AL 18 7/8 UNF	20,57	STA AL 18 7/8 UNF	18,13
22	L	7/8 UNF	AL 22 7/8 UNF	26,44	STA AL 22 7/8 UNF	23,17
22	L	1 1/16 UNF	AL 22 1 1/16 UN	25,96	STA AL 22 1 1/16 UNF	22,69
22	L	1 5/16 UNF	AL 22 1 5/16 UN	30,70	STA AL 22 1 5/16 UNF	27,43
28	L	1 1/16 UNF	AL 28 1 1/16 UN	33,88	STA AL 28 1 1/16 UNF	28,30
28	L	1 5/16 UNF	AL 28 1 5/16 UN	33,91	STA AL 28 1 5/16 UNF	28,34
35	L	1 5/16 UNF	AL 35 1 5/16 UN	40,68	STA AL 35 1 5/16 UNF	33,31
35	L	1 5/8 UNF	AL 35 1 5/8 UNF	44,33	STA AL 35 1 5/8 UNF	36,96
42	L	1 5/8 UNF	AL 42 1 5/8 UNF	54,04	STA AL 42 1 5/8 UNF	45,59
8	S	7/16 UNF	AS 8 7/16 UNF	12,37	STA AS 8 7/16 UNF	11,53
10	S	9/16 UNF	AS 10 9/16 UNF	13,80	STA AS 10 9/16 UNF	12,71
12	S	9/16 UNF	AS 12 9/16 UNF	16,54	STA AS 12 9/16 UNF	15,30
12	S	3/4 UNF	AS 12 3/4 UNF	17,50	STA AS 12 3/4 UNF	16,25
16	S	3/4 UNF	AS 16 3/4 UNF	18,27	STA AS 16 3/4 UNF	15,72
16	S	7/8 UNF	AS 16 7/8 UNF	22,56	STA AS 16 7/8 UNF	20,01
20	S	3/4 UNF	AS 20 3/4 UNF	28,79	STA AS 20 3/4 UNF	25,13
20	S	7/8 UNF	AS 20 7/8 UNF	28,83	STA AS 20 7/8 UNF	25,17
20	S	1 1/16 UNF	AS 20 1 1/16 UN	28,66	STA AS 20 1 1/16 UNF	24,99
25	S	1 5/16 UNF	AS 25 1 5/16 UNF	39,05	STA AS 25 1 5/16 UNF	32,74
30	S	1 5/16 UNF	AS 30 1 5/16 UNF	44,64	STA AS 30 1 5/16 UNF	36,71
30	S	1 5/8 UNF	AS 30 1 5/8 UNF	49,49	STA AS 30 1 5/8 UNF	41,56
38	S	1 5/8 UNF	AS 38 1 5/8 UNF	62,19	STA AS 38 1 5/8 UNF	51,08

Racor recto rosca cilíndrica Métrica



Union simple mâle Métrique

Straight male stud coupling Metrical cyl

Raccordo di estremità diritto cilindrico Metrico

T. P.	S.	ROSCA THREAD	REFERENCIA PART N°	€	REFERENCIA STA PART N° STA	€
6	L	M10x1	AL 6 M 10X1	1,47	STA AL 6 M 10X1	0,78
8	L	M12x1,5	AL 8 M 12X1.5	1,80	STA AL 8 M 12X1.5	1,04
10	L	M14x1,5	AL 10 M 14X1.5	2,03	STA AL 10 M 14X1.5	1,17
10	L	M16x1,5	AL 10 M 16X1.5	3,90	STA AL 10 M 16X1.5	3,05
10	L	M18x1,5	AL 10 M 18X1.5	5,25	STA AL 10 M 18X1.5	4,40
10	L	M22x1,5	AL 10 M 22X1.5	10,10	STA AL 10 M 22X1.5	9,25
12	L	M14X1,5	AL 12 M 14X1.5	7,46	STA AL 12 M 14X1.5	6,43
12	L	M16x1,5	AL 12 M 16X1.5	2,67	STA AL 12 M 16X1.5	1,63
12	L	M18x1,5	AL 12 M 18X1.5	4,79	STA AL 12 M 18X1.5	3,76
12	L	M22x1,5	AL 12 M 22X1.5	5,41	STA AL 12 M 22X1.5	4,38
15	L	M16x1,5	AL 15 M 16X1.5	8,04	STA AL 15 M 16X1.5	6,68
15	L	M18x1,5	AL 15 M 18X1.5	3,22	STA AL 15 M 18X1.5	1,83
15	L	M22x1,5	AL 15 M 22X1.5	5,86	STA AL 15 M 22X1.5	4,47
18	L	M22x1,5	AL 18 M 22X1.5	4,77	STA AL 18 M 22X1.5	2,47
22	L	M22x1,5	AL 22 M 22X1.5	22,44	STA AL 22 M 22X1.5	19,33
22	L	M26x1,5	AL 22 M 26X1.5	7,10	STA AL 22 M 26X1.5	3,98
28	L	M33x2	AL 28 M 33X2	12,43	STA AL 28 M 33X2	7,14
35	L	M42x2	AL 35 M 42X2	17,90	STA AL 35 M 42X2	12,60
42	L	M48x2	AL 42 M 48X2	22,13	STA AL 42 M 48X2	14,00
6	S	M12x1,5	AS 6 M 12X1.5	2,02	STA AS 6 M 12X1.5	1,26
8	S	M14x1,5	AS 8 M 14X1.5	2,21	STA AS 8 M 14X1.5	1,40
10	S	M16x1,5	AS 10 M 16X1.5	2,84	STA AS 10 M 16X1.5	1,82
12	S	M18x1,5	AS 12 M 18X1.5	3,10	STA AS 12 M 18X1.5	1,92
12	S	M22x1,5	AS 12 M 22X1.5	19,91	STA AS 12 M 22X1.5	18,70
14	S	M20x1,5	AS 14 M 20X1.5	5,69	STA AS 14 M 20X1.5	3,72
16	S	M22x1,5	AS 16 M 22X1.5	5,27	STA AS 16 M 22X1.5	2,83
20	S	M27x2	AS 20 M 27X2	8,02	STA AS 20 M 27X2	4,54
25	S	M33x2	AS 25 M 33X2	13,78	STA AS 25 M 33X2	7,79
30	S	M42x2	AS 30 M 42X2	20,99	STA AS 30 M 42X2	15,53
38	S	M48x2	AS 38 M 48X2	26,13	STA AS 38 M 48X2	18,61

Racores DIN 2353

Raccords à bague DIN 2353
DIN 2353 Pipe fittings
Raccordi ad anello DIN 2353

Racor recto rosca cilíndrica Métrica con junta

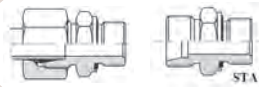

Union simple mâle Métrique cyl + o'ring

Straight male stud coupling with captive seal Metrical cyl
Raccordo di estremità diritto cilindrico Metrico con o'ring

T. P.	S.	ROSCA THREAD	REFERENCIA PART N°	€	REFERENCIA STA PART N° STA	€
6	L	M10x1	AL 6 M 10X1 WD	1,87	STA AL 6 M 10X1 WD	1,40
8	L	M12x1,5	AL 8 M 12X1.5 WD	2,24	STA AL 8 M 12X1.5 WD	1,62
10	L	M14x1,5	AL 10 M 14X1.5 WD	2,49	STA AL 10 M 14X1.5 WD	1,80
10	L	M16x1,5	AL 10 M 16X1.5 WD	4,31	STA AL 10 M 16X1.5 WD	3,78
10	L	M18x1,5	AL 10 M 18X1.5 WD	5,69	STA AL 10 M 18X1.5 WD	5,28
12	L	M16x1,5	AL 12 M 16X1.5 WD	3,14	STA AL 12 M 16X1.5 WD	2,30
12	L	M18x1,5	AL 12 M 18X1.5 WD	5,24	STA AL 12 M 18X1.5 WD	4,60
12	L	M22x1,5	AL 12 M 22X1.5 WD	5,93	STA AL 12 M 22X1.5 WD	5,35
15	L	M18x1,5	AL 15 M 18X1.5 WD	3,73	STA AL 15 M 18X1.5 WD	2,57
15	L	M22x1,5	AL 15 M 22X1.5 WD	6,35	STA AL 15 M 22X1.5 WD	5,42
18	L	M22x1,5	AL 18 M 22X1.5 WD	5,33	STA AL 18 M 22X1.5 WD	2,61
22	L	M26x1,5	AL 22 M 26X1.5 WD	7,62	STA AL 22 M 26X1.5 WD	4,93
28	L	M33x2	AL 28 M 33X2 WD	13,39	STA AL 28 M 33X2 WD	6,56
35	L	M42x2	AL 35 M 42X2 WD	19,17	STA AL 35 M 42X2 WD	13,31
42	L	M48x2	AL 42 M 48X2 WD	23,96	STA AL 42 M 48X2 WD	17,41
6	S	M12x1,5	AS 6 M 12X1.5 WD	2,42	STA AS 6 M 12X1.5 WD	1,83
10	S	M16x1,5	AS 10 M 16X1.5 WD	3,31	STA AS 10 M 16X1.5 WD	2,49
12	S	M18x1,5	AS 12 M 18X1.5 WD	3,64	STA AS 12 M 18X1.5 WD	2,67
14	S	M20x1,5	AS 14 M 20X1.5 WD	6,17	STA AS 14 M 20X1.5 WD	4,60
16	S	M22x1,5	AS 16 M 22X1.5 WD	5,82	STA AS 16 M 22X1.5 WD	3,72
20	S	M27x2	AS 20 M 27X2 WD	8,53	STA AS 20 M 27X2 WD	5,52
25	S	M33x2	AS 25 M 33X2 WD	14,72	STA AS 25 M 33X2 WD	9,56
30	S	M42x2	AS 30 M 42X2 WD	22,18	STA AS 30 M 42X2 WD	16,01
38	S	M48x2	AS 38 M 48X2 WD	28,02	STA AS 38 M 48X2 WD	19,08

Racor recto rosca cónica Métrica

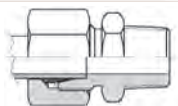

Union simple mâle métrique type A

Straight male stud coupling metrical tapered
Raccordo di estremità diritto conico Metrico

TUBO PIPE	SERIE	ROSCA THREAD	REFERENCIA PART N°	€
4	LL	M 8x1	AKLL 4 M 8X1	1,44
6	LL	M 10x1	AKLL 6 M 10X1	1,53
8	LL	M 10x1	AKLL 8 M 10X1	1,66

Reducción con rosca M-HF BSP con junta



Réduction mâle gaz-femelle gaz avec joint torique

Male-female reducing adaptor BSP cyl with captive seal
Adattatore di riduzione filettato maschio-femmina BSP con o'ring

ROSCA THREAD	ROSCA THREAD	REFERENCIA PART N°	€
M 1/8" BSP	H 1/4" BSP	RI-R 1/8 R 1/4WD	3,66
M 1/8" BSP	H 3/8" BSP	RI-R 1/8 R 3/8WD	6,79
M 1/4" BSP	H 1/8" BSP	RI-R 1/4 R 1/8WD	2,13
M 1/4" BSP	H 3/8" BSP	RI-R 1/4 R 3/8WD	3,14
M 1/4" BSP	H 1/2" BSP	RI-R 1/4 R 1/2 WD	3,56
M 1/4" BSP	H 3/4" BSP	RI-R 1/4 R 3/4 WD	12,85
M 3/8" BSP	H 1/8" BSP	RI-R 3/8 R 1/8WD	2,34
M 3/8" BSP	H 1/4" BSP	RI-R 3/8 R 1/4 WD	2,27
M 3/8" BSP	H 1/2" BSP	RI-R 3/8 R 1/2WD	3,68
M 3/8" BSP	H 3/4" BSP	RI-R 3/8 R 3/4WD	10,91
M 1/2" BSP	H 1/8" BSP	RI-R 1/2 R 1/8WD	3,40
M 1/2" BSP	H 1/4" BSP	RI-R 1/2 R 1/4WD	2,56
M 1/2" BSP	H 3/8" BSP	RI-R 1/2 R 3/8WD	3,03
M 1/2" BSP	H 3/4" BSP	RI-R 1/2 R 3/4WD	9,84
M 1/2" BSP	H 1" BSP	RI-R 1/2 R 1WD	10,36
M 1/2" BSP	H 1" 1/4 BSP	RI-R 1/2 R 1 1/4WD	33,15
M 3/4" BSP	H 3/4" BSP	RI-R 3/4 R 1/4WD	3,77
M 3/4" BSP	H 3/8" BSP	RI-R 3/4 R 3/8WD	3,69
M 3/4" BSP	H 1/2" BSP	RI-R 3/4 R 1/2WD	4,49
M 3/4" BSP	H 1" BSP	RI-R 3/4 R 1WD	10,86
M 3/4" BSP	H 1" 1/4 BSP	RI-R 3/4 R 1 1/4WD	33,68
M 3/4" BSP	H 1" 1/2 BSP	RI-R 3/4 R 1 1/2WD	40,25
M 1" BSP	H 1/4" BSP	RI-R 1 R 1/4WD	8,07
M 1" BSP	H 3/8" BSP	RI-R 1 R 3/8WD	8,07
M 1" BSP	H 1/2" BSP	RI-R 1 R 1/2WD	6,20
M 1" BSP	H 3/4" BSP	RI-R 1 R 3/4WD	8,10
M 1" BSP	H 1" 1/4 BSP	RI-R 1 R 1 1/4WD	34,15
M 1" BSP	H 1" 1/2 BSP	RI-R 1 R 1 1/2WD	37,17
M 1" 1/4 BSP	H 1/2" BSP	RI-R 1 1/4 R 1/2WD	16,18
M 1" 1/4 BSP	H 3/4" BSP	RI-R 1 1/4 R 3/4WD	11,43
M 1" 1/4 BSP	H 1" BSP	RI-R 1 1/4 R 1WD	14,40
M 1" 1/4 BSP	H 1" 1/2 BSP	RI-R 1 1/4 R 1 1/2WD	45,33
M 1" 1/2 BSP	H 1/2" BSP	RI-R 1 1/2 R 1/2WD	31,40
M 1" 1/2 BSP	H 3/4" BSP	RI-R 1 1/2 R 3/4WD	16,74
M 1" 1/2 BSP	H 1" BSP	RI-R 1 1/2 R 1WD	16,85
M 1" 1/2 BSP	H 1" 1/4 BSP	RI-R 1 1/2 R 1 1/4WD	24,09

Racores DIN 2353

Raccords à bague DIN 2353
DIN 2353 Pipe fittings
Raccordi ad anello DIN 2353

Pipe

DIN 2353 Pipe Fittings

Gas tube fittings

JIC 37° fittings

SAE Flanges

Clamps

Machines for processing rigid pipes

Racor en codo rosca cónica BSPT



Union coude mâle gaz conique type G

Male stud elbow BSPT

Raccordo di estremità a 90° Metrico conico BSPT

T. P.	S.	ROSCA THREAD	REFERENCIA PART N°	€	REFERENCIA STA PART N° STA	€
4	LL	1/8" BSPT	CKLL 4 R 1/8	4,31	STA CKLL 4 R 1/8	3,68
6	LL	1/8" BSPT	CKLL 6 R 1/8	4,39	STA CKLL 6 R 1/8	3,85
8	LL	1/8" BSPT	CKLL 8 R 1/8	4,96	STA CKLL 6 R 1/8	3,85
6	L	1/8" BSPT	CKL 6 R 1/8	4,50	STA CKL 6 R 1/8	3,21
6	L	1/4" BSPT	CKL 6 R 1/4	4,81	STA CKL 6 R 1/4	3,45
8	L	1/8" BSPT	CKL 8 R 1/8	4,88	STA CKL 8 R 1/8	3,74
8	L	1/4" BSPT	CKL 8 R 1/4	4,86	STA CKL 8 R 1/4	3,71
8	L	3/8" BSPT	CKL 8 R 3/8	6,31	STA CKL 8 R 3/8	5,67
10	L	1/4" BSPT	CKL 10 R 1/4	5,30	STA CKL 10 R 1/4	3,91
10	L	3/8" BSPT	CKL 10 R 3/8	6,40	STA CKL 10 R 3/8	4,53
10	L	1/2" BSPT	CKL 10 R 1/2	7,54	STA CKL 10 R 1/2	6,81
12	L	1/4" BSPT	CKL 12 R 1/4	6,54	STA CKL 12 R 1/4	4,53
12	L	3/8" BSPT	CKL 12 R 3/8	6,40	STA CKL 12 R 3/8	4,48
12	L	1/2" BSPT	CKL 12 R 1/2	7,68	STA CKL 12 R 1/2	8,13
15	L	3/8" BSPT	CKL 15 R 3/8	7,94	STA CKL 15 R 3/8	6,81
15	L	1/2" BSPT	CKL 15 R 1/2	7,82	STA CKL 15 R 1/2	6,37
18	L	1/2" BSPT	CKL 18 R 1/2	10,47	STA CKL 18 R 1/2	8,32
22	L	3/4" BSPT	CKL 22 R 3/4	21,98	STA CKL 22 R 3/4	19,13
28	L	1" BSPT	CKL 28 R 1	34,04	STA CKL 28 R 1	29,16
35	L	1 1/4" BSPT	CKL 35 R 1 1/4	53,61	STA CKL 35 R 1 1/4	47,14
42	L	1 1/2" BSPT	CKL 42 R 1 1/2	60,81	STA CKL 42 R 1 1/2	53,13
6	S	1/4" BSPT	CKS 6 R 1/4	5,25	STA CKS 6 R 1/4	4,55
8	S	1/4" BSPT	CKS 8 R 1/4	6,05	STA CKS 8 R 1/4	4,99
10	S	3/8" BSPT	CKS 10 R 3/8	6,94	STA CKS 10 R 3/8	5,99
12	S	3/8" BSPT	CKS 12 R 3/8	7,77	STA CKS 12 R 3/8	5,95
12	S	1/2" BSPT	CKS 12 R 1/2	11,44	STA CKS 12 R 1/2	8,58
14	S	1/2" BSPT	CKS 14 R 1/2	12,08	STA CKS 14 R 1/2	10,41
16	S	1/2" BSPT	CKS 16 R 1/2	11,35	STA CKS 16 R 1/2	7,77
20	S	3/4" BSPT	CKS 20 R 3/4	27,94	STA CKS 20 R 3/4	24,75
25	S	1" BSPT	CKS 25 R 1	30,96	STA CKS 25 R 1	25,96
30	S	1 1/4" BSPT	CKS 30 R 1 1/4	55,22	STA CKS 30 R 1 1/4	48,30
38	S	1 1/2" BSPT	CKS 38 R 1 1/2	64,90	STA CKS 38 R 1 1/2	55,19

Racor en codo rosca cónica Métrica



Equerre mâle Métrique type A

Male stud elbow Metric tapered

Raccordo di estremità a 90° Metrico conico

TUBO PIPE	SERIE	ROSCA THREAD	REFERENCIA PART N°	€
4	LL	M8x1	CKLL 4 M 8X1	4,72
6	LL	M10x1	CKLL 6 M 10X1	4,89
8	LL	M10x1	CKLL 8 M 10X1	5,45
6	L	M10x1	CKL 6 M 10X1	4,97
8	L	M12x1,5	CKL 8 M 12X1.5	5,39
10	L	M14x1,5	CKL 10 M 14X1.5	6,02
12	L	M16x1,5	CKL 12 M 16X1.5	7,26
15	L	M18x1,5	CKL 15 M 18X1.5	10,44
18	L	M22x1,5	CKL 18 M 22X1.5	14,99
6	S	M12x1,5	CKS 6 M 12X1.5	6,53
8	S	M14x1,5	CKS 8 M 14X1.5	7,46
10	S	M16x1,5	CKS 10 M 16X1.5	8,22
14	S	M20x1,5	CKS 14 M 20X1.5	19,88
16	S	M22x1,5	CKS 16 M 22X1.5	17,60

Racor en codo rosca cónica NPT

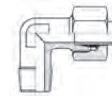

Union coude mâle NPT

Male stud elbow NPT

Raccordo di estremità a 90° conico NPT

TUBO PIPE	SERIE	ROSCA THREAD	REFERENCIA PART N°	€
4	LL	1/8" NPT	CKLL 4 1/8 NPT	5,66
6	LL	1/8" NPT	CKLL 6 1/8 NPT	5,69
8	LL	1/8" NPT	CKLL 8 1/8 NPT	6,40
6	L	1/8" NPT	CKL 6 1/8 NPT	5,57
6	L	1/4" NPT	CKL 6 1/4 NPT	7,96
8	L	1/4" NPT	CKL 8 1/4 NPT	6,01
10	L	1/4" NPT	CKL 10 1/4 NPT	6,64
12	L	1/4" NPT	CKL 12 1/4 NPT	9,28
12	L	3/8" NPT	CKL 12 3/8 NPT	8,11
12	L	1/2" NPT	CKL 12 1/2 NPT	13,92
15	L	1/2" NPT	CKL 15 1/2 NPT	10,64
18	L	1/2" NPT	CKL 18 1/2 NPT	15,83
22	L	3/4" NPT	CKL 22 3/4 NPT	20,17
28	L	1" NPT	CKL 28 1 NPT	33,11
6	S	1/4" NPT	CKS 6 1/4 NPT	6,45
8	S	1/4" NPT	CKS 8 1/4 NPT	7,42
10	S	3/8" NPT	CKS 10 3/8 NPT	8,32
12	S	3/8" NPT	CKS 12 3/8 NPT	9,26
14	S	1/2" NPT	CKS 14 1/2 NPT	20,16
16	S	1/2" NPT	CKS 16 1/2 NPT	13,97
20	S	3/4" NPT	CKS 20 3/4 NPT	22,14
25	S	1" NPT	CKS 25 1 NPT	42,45

Racor en codo orientable BSP-Métrico



Coude réglable mâle BSP - Métrique

90° Adjustable male stud elbow BSP - Metric

Raccordo a 90° orientabile maschio BSP - Metrico

TUBO PIPE	SERIE	ROSCA THREAD	REFERENCIA PART N°	€
6	L	1/8" BSP	STA WEE 6L R 1/8	11,48
8	L	1/4" BSP	STA WEE 8L R 1/4	11,95
10	L	1/4" BSP	STA WEE 10L R 1/4	12,12
12	L	3/8" BSP	STA WEE 12L R 3/8	11,83
15	L	1/2" BSP	STA WEE 15L R 1/2	15,30
18	L	1/2" BSP	STA WEE 18L R 1/2	18,77
22	L	3/4" BSP	STA WEE 22L R 3/4	22,30
16	S	1/2" BSP	STA WEE 16S R 1/2	17,60
20	S	3/4" BSP	STA WEE 20S R 3/4	20,96
25	S	1" BSP	STA WEE 25S R 1	38,78

Racores DIN 2353

Raccords à bague DIN 2353

DIN 2353 Pipe fittings

Raccordi ad anello DIN 2353

Racor de reducción TL Métrica (serie ligera)

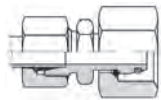

Union simple femelle tournant Métrique (L)

Standpipe reducers with taper (L)

Raccordo di riduzione cono 24 (L)

TUBO PIPE		SERIE	REFERENCIA PART N°	€
6	8	L	KORL 8-6TLM	4,45
6	10	L	KORL 10-6TLM	4,64
10	8	L	KORL 10-8 TLM	4,71
6	12	L	KORL 12-6TLM	4,92
8	12	L	KORL 12-8TLM	4,98
10	12	L	KORL 12-10TLM	5,08
6	15	L	KORL 15-6TLM	5,72
8	15	L	KORL 15-8TLM	5,53
10	15	L	KORL 15-10TLM	5,64
12	15	L	KORL 15-12TLM	5,82
6	18	L	KORL 18-6TLM	11,43
8	18	L	KORL 18-8TLM	7,15
10	18	L	KORL 18-10TLM	7,17
12	18	L	KORL 18-12TLM	7,36
15	18	L	KORL 18-15TLM	7,73
6	22	L	KORL 22-6TLM	14,65
8	22	L	KORL 22-8TLM	13,22
10	22	L	KORL 22-10TLM	12,38
12	22	L	KORL 22-12TLM	9,24
15	22	L	KORL 22-15TLM	9,60
18	22	L	KORL 22-18TLM	10,59
6	28	L	KORL 28-6TLM	22,65
8	28	L	KORL 28-8TLM	21,48
10	28	L	KORL 28-10TLM	17,87
12	28	L	KORL 28-12TLM	16,66
15	28	L	KORL 28-15TLM	16,74
18	28	L	KORL 28-18TLM	17,72
22	28	L	KORL 28-22TLM	18,56
15	35	L	KORL 35-15TLM	30,84
18	35	L	KORL 35-18TLM	26,54
22	35	L	KORL 35-22TLM	24,62
28	35	L	KORL 35-28TLM	26,20
18	42	L	KORL 42-18TLM	47,71
22	42	L	KORL 42-22TLM	31,87
28	42	L	KORL 42-28TLM	32,53
35	42	L	KORL 42-35TLM	36,81

Racor de reducción TL Métrica (serie pesada)

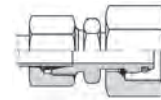

Union simple femelle tournant Métrique (S)

Standpipe reducers with taper (S)

Raccordo di riduzione cono 24 (S)

TUBO PIPE		SERIE	REFERENCIA PART N°	€
6	8	S	KORS 8-6TLM	9,73
6	10	S	KORS 10-6TLM	6,48
8	10	S	KORS 10-8TLM	6,53
6	12	S	KORS 12-6TLM	5,64
8	12	S	KORS 12-8TLM	5,70
10	12	S	KORS 12-10TLM	5,94
6	14	S	KORS 14-6TLM	15,29
8	14	S	KORS 14-8TLM	14,96
10	14	S	KORS 14-10TLM	15,21
12	14	S	KORS 14-12TLM	15,38
8	16	S	KORS 16-8TLM	7,63
10	16	S	KORS 16-10TLM	7,87
12	16	S	KORS 16-12TLM	8,05
14	16	S	KORS 16-14TLM	17,95
6	20	S	KORS 20-6TLM	14,00
8	20	S	KORS 20-8TLM	13,14
10	20	S	KORS 20-10TLM	11,53
12	20	S	KORS 20-12TLM	10,02
14	20	S	KORS 20-14TLM	24,35
16	20	S	KORS 20-16TLM	11,34
6	25	S	KORS 25-6TLM	23,32
8	25	S	KORS 25-8TLM	22,93
10	25	S	KORS 25-10TLM	21,29
12	25	S	KORS 25-12TLM	17,19
14	25	S	KORS 25-14TLM	36,27
16	25	S	KORS 25-16TLM	17,54
20	25	S	KORS 25-20TLM	19,30
10	30	S	KORS 30-10TLM	26,26
12	30	S	KORS 30-12TLM	22,47
16	30	S	KORS 30-16TLM	22,76
20	30	S	KORS 30-20TLM	23,40
25	30	S	KORS 30-25TLM	27,07
12	38	S	KORS 38-12TLM	43,33
16	38	S	KORS 38-16TLM	37,38
20	38	S	KORS 38-20TLM	35,98
25	38	S	KORS 38-25TLM	38,61
30	38	S	KORS 38-30TLM	40,24

Racores DIN 2353

Raccords à bague DIN 2353
DIN 2353 Pipe fittings
Raccordi ad anello DIN 2353

Pipe

DIN 2353 Pipe Fittings

Gas tube fittings

JIC 37° fittings

SAE Flanges

Clamps

Machines for processing rigid pipes

Racor en codo regulable con tuercas y anillo



Coude orientable tube lisse équipé
Adjustable stud elbow with nut and ring
Raccordo orientabile a 90° con dado e anello

T. P.	S.	ROSCA THREAD	REFERENCIA PART N°	€	REFERENCIA STA PART N° STA	€
6	L	M12x1,5	EEL 6 CTA	5,24	STA EEL 6 CTA	4,65
8	L	M14x1,5	EEL 8 CTA	5,42	STA EEL 8 CTA	4,57
10	L	M16x1,5	EEL 10 CTA	5,86	STA EEL 10 CTA	5,03
12	L	M18x1,5	EEL 12 CTA	7,32	STA EEL 12 CTA	6,29
15	L	M22x1,5	EEL 15 CTA	8,53	STA EEL 15 CTA	7,29
18	L	M26x1,5	EEL 18 CTA	12,38	STA EEL 18 CTA	10,07
22	L	M30x2	EEL 22 CTA	17,21	STA EEL 22 CTA	14,10
28	L	M36x2	EEL 28 CTA	27,14	STA EEL 28 CTA	21,80
35	L	M45x2	EEL 35 CTA	41,51	STA EEL 35 CTA	34,27
42	L	M52x2	EEL 42 CTA	55,63	STA EEL 42 CTA	47,23
6	S	M14x1,5	EES 6 CTA	5,97	STA EES 6 CTA	5,23
8	S	M16x1,5	EES 8 CTA	6,61	STA EES 8 CTA	5,88
10	S	M18x1,5	EES 10 CTA	7,64	STA EES 10 CTA	6,65
12	S	M20x1,5	EES 12 CTA	8,18	STA EES 12 CTA	7,09
14	S	M22x1,5	EES 14 CTA	12,43	STA EES 14 CTA	10,62
16	S	M24x1,5	EES 16 CTA	12,55	STA EES 16 CTA	10,30
20	S	M30x2	EES 20 CTA	18,79	STA EES 20 CTA	15,57
25	S	M36x2	EES 25 CTA	29,25	STA EES 25 CTA	23,73
30	S	M42x2	EES 30 CTA	42,32	STA EES 30 CTA	34,57
38	S	M52x2	EES 38 CTA	58,58	STA EES 38 CTA	50,79

Racor en L regulable con tuercas y anillo

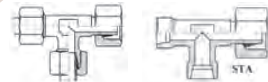

L Orientable reversé tube lisse équipé
Adjustable stud barrel L with nut and ring
Raccordo orientabile a T con dado e anello laterale

TUBO PIPE	S.	ROSCA THREAD	REFERENCIA PART N°	€	REFERENCIA STA PART N° STA	€	
6	6	L	M12x1,5	LEL 6 CTA	8,89	STA LEL 6 CTA	7,27
8	8	L	M14x1,5	LEL 8 CTA	9,22	STA LEL 8 CTA	7,49
10	10	L	M16x1,5	LEL 10 CTA	9,97	STA LEL 10 CTA	8,39
12	12	L	M18x1,5	LEL 12 CTA	11,37	STA LEL 12 CTA	9,35
15	15	L	M22x1,5	LEL 15 CTA	14,98	STA LEL 15 CTA	12,11
18	18	L	M26x1,5	LEL 18 CTA	20,92	STA LEL 18 CTA	16,02
22	22	L	M30x2	LEL 22 CTA	31,24	STA LEL 22 CTA	24,19
28	28	L	M36x2	LEL 28 CTA	48,03	STA LEL 28 CTA	36,80
35	35	L	M45x2	LEL 35 CTA	65,39	STA LEL 35 CTA	50,47
42	42	L	M52x2	LEL 42 CTA	86,71	STA LEL 42 CTA	69,55
6	6	S	M14x1,5	LES 6 CTA	10,08	STA LES 6 CTA	8,50
8	8	S	M16x1,5	LES 8 CTA	11,13	STA LES 8 CTA	9,47
10	10	S	M18x1,5	LES 10 CTA	12,62	STA LES 10 CTA	10,55
12	12	S	M20x1,5	LES 12 CTA	14,13	STA LES 12 CTA	11,65
14	14	S	M22x1,5	LES 14 CTA	22,14	STA LES 14 CTA	18,21
16	16	S	M24x1,5	LES 16 CTA	22,32	STA LES 16 CTA	17,23
20	20	S	M30x2	LES 20 CTA	33,13	STA LES 20 CTA	25,81
25	25	S	M36x2	LES 25 CTA	50,96	STA LES 25 CTA	38,33
30	30	S	M42x2	LES 30 CTA	67,35	STA LES 30 CTA	51,38
38	38	S	M52x2	LES 38 CTA	98,34	STA LES 38 CTA	76,08

Racor en T regulable con tuercas y anillo



TÉ Orientable tube lisse équipé au centre
Adjustable stud branch TEE with nut and ring
Raccordo orientabile a T con dado e anello centrale

TUBO PIPE	S.	ROSCA THREAD	REFERENCIA PART N°	€	REFERENCIA STA PART N° STA	€	
6	6	L	M12x1,5	TEL 6 CTA	8,60	STA TEL 6 CTA	7,19
8	8	L	M14x1,5	TEL 8 CTA	9,01	STA TEL 8 CTA	7,50
10	10	L	M16x1,5	TEL 10 CTA	10,36	STA TEL 10 CTA	8,69
12	12	L	M18x1,5	TEL 12 CTA	10,93	STA TEL 12 CTA	8,78
15	15	L	M22x1,5	TEL 15 CTA	14,65	STA TEL 15 CTA	11,72
18	18	L	M26x1,5	TEL 18 CTA	19,93	STA TEL 18 CTA	15,06
22	22	L	M30x2	TEL 22 CTA	31,49	STA TEL 22 CTA	25,25
28	28	L	M36x2	TEL 28 CTA	47,54	STA TEL 28 CTA	36,32
35	35	L	M45x2	TEL 35 CTA	64,21	STA TEL 35 CTA	49,29
42	42	L	M52x2	TEL 42 CTA	87,34	STA TEL 42 CTA	70,17
6	6	S	M14x1,5	TES 6 CTA	9,84	STA TES 6 CTA	8,39
8	8	S	M16x1,5	TES 8 CTA	10,83	STA TES 8 CTA	9,15
10	10	S	M18x1,5	TES 10 CTA	12,19	STA TES 10 CTA	10,12
12	12	S	M20x1,5	TES 12 CTA	13,99	STA TES 12 CTA	11,53
14	14	S	M22x1,5	TES 14 CTA	21,53	STA TES 14 CTA	17,60
16	16	S	M24x1,5	TES 16 CTA	20,38	STA TES 16 CTA	15,49
20	20	S	M30x2	TES 20 CTA	33,32	STA TES 20 CTA	26,34
25	25	S	M36x2	TES 25 CTA	50,54	STA TES 25 CTA	37,93
30	30	S	M42x2	TES 30 CTA	65,96	STA TES 30 CTA	49,98
38	38	S	M52x2	TES 38 CTA	96,02	STA TES 38 CTA	74,84

Racor en codo tubo-TL Métrica



Coude orientable Métrique + o'ring
Adjustable stud elbow with o'ring
Raccordo orientabile a 90° con o'ring

TUBO PIPE	S.	ROSCA THREAD	REFERENCIA PART N°	€	REFERENCIA STA PART N° STA	€	
6	6	L	M12x1,5	EEL 6 TLM	5,89	STA EEL 6 TLM	5,18
8	8	L	M14x1,5	EEL 8 TLM	5,92	STA EEL 8 TLM	5,13
10	10	L	M16x1,5	EEL 10 TLM	6,48	STA EEL 10 TLM	5,62
12	12	L	M18x1,5	EEL 12 TLM	8,85	STA EEL 12 TLM	7,79
15	15	L	M22x1,5	EEL 15 TLM	9,18	STA EEL 15 TLM	7,79
18	18	L	M26x1,5	EEL 18 TLM	13,15	STA EEL 18 TLM	10,86
22	22	L	M30x2	EEL 22 TLM	17,99	STA EEL 22 TLM	14,89
28	28	L	M36x2	EEL 28 TLM	27,71	STA EEL 28 TLM	22,51
35	35	L	M45x2	EEL 35 TLM	41,51	STA EEL 35 TLM	33,76
42	42	L	M52x2	EEL 42 TLM	58,41	STA EEL 42 TLM	50,30
6	6	S	M14x1,5	EES 6 TLM	6,73	STA EES 6 TLM	5,94
8	8	S	M16x1,5	EES 8 TLM	7,53	STA EES 8 TLM	6,55
10	10	S	M18x1,5	EES 10 TLM	8,50	STA EES 10 TLM	7,42
12	12	S	M20x1,5	EES 12 TLM	8,79	STA EES 12 TLM	7,58
14	14	S	M22x1,5	EES 14 TLM	12,83	STA EES 14 TLM	10,83
16	16	S	M24x1,5	EES 16 TLM	13,58	STA EES 16 TLM	11,18
20	20	S	M30x2	EES 20 TLM	19,36	STA EES 20 TLM	15,92
25	25	S	M36x2	EES 25 TLM	29,52	STA EES 25 TLM	23,66
30	30	S	M42x2	EES 30 TLM	41,40	STA EES 30 TLM	33,96
38	38	S	M52x2	EES 38 TLM	61,87	STA EES 38 TLM	*

Racores DIN 2353

Raccords à bague DIN 2353
DIN 2353 Pipe fittings
Raccordi ad anello DIN 2353

Racor en T tubo-TL Métrica



TÉ Orientable Métrique + o'ring
Adjustable stud branch TEE with o'ring
Raccordo orientabile a T con o'ring centrale

TUBO PIPE	S.	ROSCA THREAD	REFERENCIA PART N°	€	REFERENCIA STA PART N° STA	€	
6	6	L	M12x1,5	TEL 6 TLM	10,25	STA TEL 6 TLM	8,73
8	8	L	M14x1,5	TEL 8 TLM	10,69	STA TEL 8 TLM	9,03
10	10	L	M16x1,5	TEL 10 TLM	12,12	STA TEL 10 TLM	10,22
12	12	L	M18x1,5	TEL 12 TLM	12,39	STA TEL 12 TLM	10,39
15	15	L	M22x1,5	TEL 15 TLM	16,58	STA TEL 15 TLM	13,57
18	18	L	M26x1,5	TEL 18 TLM	22,44	STA TEL 18 TLM	17,47
22	22	L	M30x2	TEL 22 TLM	34,66	STA TEL 22 TLM	27,91
28	28	L	M36x2	TEL 28 TLM	51,47	STA TEL 28 TLM	40,09
35	35	L	M45x2	TEL 35 TLM	68,21	STA TEL 35 TLM	53,17
42	42	L	M52x2	TEL 42 TLM	103,17	STA TEL 42 TLM	85,55
6	6	S	M14x1,5	TES 6 TLM	11,72	STA TES 6 TLM	10,05
8	8	S	M16x1,5	TES 8 TLM	12,88	STA TES 8 TLM	11,10
10	10	S	M18x1,5	TES 10 TLM	14,27	STA TES 10 TLM	11,99
12	12	S	M20x1,5	TES 12 TLM	16,09	STA TES 12 TLM	13,47
14	14	S	M22x1,5	TES 14 TLM	47,14	STA TES 14 TLM	44,08
16	16	S	M24x1,5	TES 16 TLM	23,45	STA TES 16 TLM	18,24
20	20	S	M30x2	TES 20 TLM	36,90	STA TES 20 TLM	29,37
25	25	S	M36x2	TES 25 TLM	55,05	STA TES 25 TLM	42,23
30	30	S	M42x2	TES 30 TLM	69,89	STA TES 30 TLM	53,76
38	38	S	M52x2	TES 38 TLM	111,09	STA TES 38 TLM	88,26

Racor en L tubo-TL Métrica

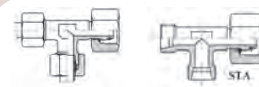

L Orientable renversé Métrique + o'ring
Adjustable stud barrel L with o'ring
Raccordo orientabile a T con o'ring laterale

TUBO PIPE	S.	ROSCA THREAD	REFERENCIA PART N°	€	REFERENCIA STA PART N° STA	€	
6	6	L	M12x1,5	LEL 6 TLM	10,53	STA LEL 6 TLM	8,98
8	8	L	M14x1,5	LEL 8 TLM	10,60	STA LEL 8 TLM	8,95
10	10	L	M16x1,5	LEL 10 TLM	11,63	STA LEL 10 TLM	9,78
12	12	L	M18x1,5	LEL 12 TLM	13,04	STA LEL 12 TLM	8,95
15	15	L	M22x1,5	LEL 15 TLM	16,95	STA LEL 15 TLM	13,98
18	18	L	M26x1,5	LEL 18 TLM	23,55	STA LEL 18 TLM	18,19
22	22	L	M30x2	LEL 22 TLM	33,72	STA LEL 22 TLM	27,10
28	28	L	M36x2	LEL 28 TLM	50,95	STA LEL 28 TLM	39,79
35	35	L	M45x2	LEL 35 TLM	69,40	STA LEL 35 TLM	54,32
42	42	L	M52x2	LEL 42 TLM	104,58	STA LEL 42 TLM	85,26
6	6	S	M14x1,5	LES 6 TLM	11,91	STA LES 6 TLM	10,24
8	8	S	M16x1,5	LES 8 TLM	11,86	STA LES 8 TLM	10,08
10	10	S	M18x1,5	LES 10 TLM	14,73	STA LES 10 TLM	12,44
12	12	S	M20x1,5	LES 12 TLM	16,25	STA LES 12 TLM	13,63
14	14	S	M22x1,5	LES 14 TLM	24,98	STA LES 14 TLM	20,69
16	16	S	M24x1,5	LES 16 TLM	25,13	STA LES 16 TLM	19,98
20	20	S	M30x2	LES 20 TLM	35,99	STA LES 20 TLM	29,16
25	25	S	M36x2	LES 25 TLM	55,48	STA LES 25 TLM	42,66
30	30	S	M42x2	LES 30 TLM	71,29	STA LES 30 TLM	55,12
38	38	S	M52x2	LES 38 TLM	113,77	STA LES 38 TLM	90,90

Racor unión TL-TL Métrica



Union tournante Métrique égale
Straight connection with o'ring
Raccordo di estremità diritto Metrico con o'ring

TUBO PIPE	SERIE	REFERENCIA PART N°	€
6	L	ATL 6	9,57
8	L	ATL 8	10,28
10	L	ATL 10	10,66
12	L	ATL 12	11,43
15	L	ATL 15	12,80
18	L	ATL 18	14,07
22	L	ATL 22	16,06
28	L	ATL 28	24,11
35	L	ATL 35	28,55
42	L	ATL 42	34,65
6	S	ATS 6	11,51
8	S	ATS 8	12,34
10	S	ATS 10	12,67
12	S	ATS 12	13,62
14	S	ATS 14	17,16
16	S	ATS 16	16,09
20	S	ATS 20	18,81
25	S	ATS 25	24,09
30	S	ATS 30	35,24
38	S	ATS 38	39,57

Tubo roscado recto métrico TLM

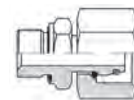

Adapteur tube lissexmale met.a/ecrou Met.+o'ring
Straight stud metric standpipe adpt.w/captive seal-o'ring Met. cyl
Adattatore diritto Metrico TLM

TUBO PIPE	SERIE	ROSCA THREAD	REFERENCIA PART N°	€
6	L	M10X1	RAL 6 TLM M 10X1	5,39
8	L	M12X1.5	RAL 8 TLM M 12X1.5	5,53
10	L	M14X1.5	RAL 10 TLM M 14X1.5	5,73
12	L	M16X1.5	RAL 12 TLM M 16X1.5	6,31
15	L	M18X1.5	RAL 15 TLM M 18X1.5	7,48
18	L	M22X1.5	RAL 18 TLM M 22X1.5	8,47
22	L	M26X1.5	RAL 22 TLM M 26X1.5	12,79
28	L	M33X2	RAL 28 TLM M 33X2	20,94
35	L	M42X2	RAL 35 TLM M 42X2	31,87
42	L	M48X2	RAL 42 TLM M 48X2	36,38
6	S	M12X1.5	RAS 6 TLM M 12X1.5	6,32
8	S	M14X1.5	RAS 8 TLM M 14X1.5	6,53
10	S	M16X1.5	RAS 10 TLM M 16X1.5	6,71
12	S	M18X1.5	RAS 12 TLM M 18X1.5	7,01
14	S	M20X1.5	RAS 14 TLM M 20X1.5	13,64
16	S	M22X1.5	RAS 16 TLM M 22X1.5	9,47
20	S	M27X2	RAS 20 TLM M 27X2	14,36
25	S	M33X2	RAS 25 TLM M 33X2	22,17
30	S	M42X2	RAS 30 TLM M 42X2	33,18
38	S	M48X2	RAS 38 TLM M 48X2	49,23

Racores DIN 2353

Raccords à bague DIN 2353
DIN 2353 Pipe fittings
Raccordi ad anello DIN 2353

Pipe

DIN 2353 Pipe Fittings

Gas tube fittings

JIC 37° fittings

SAE Flanges

Clamps

Machines for processing rigid pipes

Tubo rosca Métrica con tuerca y anillo

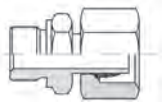

Adapteur tube lisse x mâle Métrique avec écrou et bague
Straight stud standpipe adaptor Metric cyl with nut and ring
Adattatore diritto Metrico cilindrico con guarnizione

TUBO PIPE	SERIE	ROSCA THREAD	REFERENCIA PART N°	€
6	L	M10X1	RAL 6 M 10X1 CTA	3,82
8	L	M12X1.5	RAL 8 M 12X1.5 CTA	3,95
10	L	M14X1.5	RAL 10 M 14X1.5 CTA	4,40
12	L	M16X1.5	RAL 12 M 16X1.5 CTA	5,04
15	L	M18X1.5	RAL 15 M 18X1.5 CTA	6,12
18	L	M22X1.5	RAL 18 M 22X1.5 CTA	8,09
22	L	M26X1.5	RAL 22 M 26X1.5 CTA	12,77
28	L	M33X2	RAL 28 M 33X2 CTA	19,75
35	L	M42X2	RAL 35 M 42X2 CTA	30,66
42	L	M48X2	RAL 42 M 48X2 CTA	37,55
6	S	M12X1.5	RAS 6 M 12X1.5 CTA	4,56
8	S	M14X1.5	RAS 8 M 14X1.5 CTA	5,70
10	S	M16X1.5	RAS 10 M 16X1.5 CTA	5,39
12	S	M18X1.5	RAS 12 M 18X1.5 CTA	5,87
14	S	M20X1.5	RAS 14 M 20X1.5 CTA	15,33
16	S	M22X1.5	RAS 16 M 22X1.5 CTA	13,35
20	S	M27X2	RAS 20 M 27X2 CTA	23,49
25	S	M33X2	RAS 25 M 33X2 CTA	21,14
30	S	M42X2	RAS 30 M 42X2 CTA	31,11
38	S	M48X2	RAS 38 M 48X2 CTA	48,18

Tubo roscado recto BSP TLM

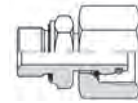

Adapteur tube lissexmale gaz a/ecrou+o'ring
Straight stud standpipe adpt. w/captive seal&o'ring BSP cyl
Adattatore diritto BSP TLM

TUBO PIPE	SERIE	ROSCA THREAD	REFERENCIA PART N°	€
6	L	1/8"BSP	RAL 6 TLM R 1/8	4,14
8	L	1/4"BSP	RAL 8 TLM R 1/4	4,35
10	L	1/4"BSP	RAL 10 TLM R 1/4	4,51
12	L	3/8 BSP	RAL 12 TLM R 3/8	4,67
15	L	1/2"BSP	RAL 15 TLM R 1/2	6,23
18	L	1/2"BSP	RAL 18 TLM R 1/2	7,04
22	L	3/4"BSP	RAL 22 TLM R 3/4	10,48
28	L	1"BSP	RAL 28 TLM R 1	15,42
35	L	1 1/4 BSP	RAL 35 TLM R 1 1/4	26,86
42	L	1"1/2 BSP	RAL 42 TLM R 1 1/2	29,61
6	S	1/4"BSP	RAS 6 TLM R 1/4	4,75
8	S	1/4"BSP	RAS 8 TLM R 1/4	4,83
10	S	3/8"BSP	RAS 10 TLM R 3/8	4,91
12	S	3/8"BSP	RAS 12 TLM R 3/8	5,06
14	S	1/2"BSP	RAS 14 TLM R 1/2	9,91
16	S	1/2"BSP	RAS 16 TLM R 1/2	7,75
20	S	3/4"BSP	RAS 20 TLM R 3/4	11,41
25	S	1"BSP	RAS 25 TLM R 1	16,50
30	S	1"1/4 BSP	RAS 30 TLM R 1 1/4	25,09
38	S	1" 1/2 BSP	RAS 38 TLM R 1 1/2	38,88

Tubo roscado recto BSP con tuerca y anillo

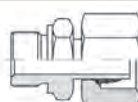

Adapteur tube lisse x mâle gaz + o'ring (avec écrou et bague)
Straight stud standpipe adaptor with captive seal BSP cyl with nut and ring
Adattatore diritto BSP cilindrico con guarnizione

TUBO PIPE	SERIE	ROSCA THREAD	REFERENCIA PART N°	€
6	L	1/8"BSP	RAL 6 R 1/8 CTA	3,11
8	L	1/4"BSP	RAL 8 R 1/4 CTA	3,46
10	L	1/4"BSP	RAL 10 R 1/4 CTA	3,57
12	L	3/8"BSP	RAL 12 R 3/8 CTA	3,89
15	L	1/2"BSP	RAL 15 R 1/2 CTA	5,28
18	L	1/2"BSP	RAL 18 R 1/2 CTA	6,94
22	L	3/4"BSP	RAL 22 R 3/4 CTA	10,22
28	L	1"BSP	RAL 28 R 1 CTA	15,99
35	L	1"1/4 BSP	RAL 35 R 1 1/4 CTA	26,62
6	S	1/4"BSP	RAS 6 R 1/4 CTA	3,43
8	S	1/4"BSP	RAS 8 R 1/4 CTA	3,50
10	S	3/8"BSP	RAS 10 R 3/8 CTA	3,87
12	S	3/8"BSP	RAS 12 R 3/8 CTA	4,04
14	S	1/2"BSP	RAS 14 R 1/2 CTA	8,02
16	S	1/2"BSP	RAS 16 R 1/2 CTA	7,30
20	S	3/4"BSP	RAS 20 R 3/4 CTA	11,66
25	S	1"BSP	RAS 25 R 1 CTA	17,63
30	S	1"1/4 BSP	RAS 30 R 1 1/4 CTA	24,72
38	S	1"1/2 BSP	RAS 38 R 1 1/2 CTA	38,40

Racores DIN 2353

Raccords à bague DIN 2353
DIN 2353 Pipe fittings
Raccordi ad anello DIN 2353

Racor recto para soldar



Mamelon hexagonal à souder Métrique (DIN 2353) équipé avec bague et écrou

Weldable straight coupling

Raccordo diritto a saldare

TUBO PIPE	SERIE	REFERENCIA PART N°	€	REFERENCIA STA PART N° STA	€
6	L	ASL 6	4,24	STA ASL 6	3,61
8	L	ASL 8	3,67	STA ASL 8	2,96
10	L	ASL 10	3,92	STA ASL 10	3,11
12	L	ASL 12	4,85	STA ASL 12	3,91
15	L	ASL 15	5,46	STA ASL 15	4,15
18	L	ASL 18	7,06	STA ASL 18	4,92
22	L	ASL 22	9,34	STA ASL 22	6,52
28	L	ASL 28	15,82	STA ASL 28	9,28
35	L	ASL 35	20,55	STA ASL 35	13,40
42	L	ASL 42	27,68	STA ASL 42	19,44
6	S	ASS 6	4,47	STA ASS 6	3,72
8	S	ASS 8	4,96	STA ASS 8	4,11
10	S	ASS 10	4,31	STA ASS 10	3,26
12	S	ASS 12	5,56	STA ASS 12	4,34
14	S	ASS 14	6,63	STA ASS 14	4,61
16	S	ASS 16	7,06	STA ASS 16	4,81
20	S	ASS 20	10,70	STA ASS 20	6,86
25	S	ASS 25	15,18	STA ASS 25	9,09
30	S	ASS 30	23,10	STA ASS 30	13,74
38	S	ASS 38	31,54	STA ASS 38	20,73

Boquilla para soldar

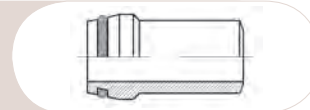

Collet cone Métrique (DIN 2353) à souder (BW) o'ring

Welding nipple

Ogiva a saldare

TUBO PIPE	SERIE	REFERENCIA PART N°	€
8	S	ORIS 8X1.5	3,40
10	S	ORIS 10X1.5	3,40
10	S	ORIS 10X2	3,40
12	S	ORIS 12X1.5	3,64
12	S	ORIS 12X2	3,64
12	S	ORIS 12X2.5	3,64
14	S	ORIS 14X2	4,40
14	S	ORIS 14X3	4,40
16	S	ORIS 16X2	4,34
16	S	ORIS 16X2.5	4,34
16	S	ORIS 16X3	4,34
20	S	ORIS 20X2.5	5,32
20	S	ORIS 20X3	5,32
20	S	ORIS 20X4	5,32
25	S	ORIS 25X3	6,64
25	S	ORIS 25X4	6,64
30	S	ORIS 30X3	8,73
30	S	ORIS 30X4	8,73
30	S	ORIS 30X5	8,73
38	S	ORIS 38X4	12,27
38	S	ORIS 38X5	12,27

Racor pasatabique para soldar

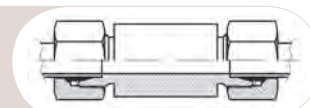

Union double passe cloison Métrique à souder

Weldable bulkhead coupling

Raccordo passaparete a saldare

TUBO PIPE	SERIE	REFERENCIA PART N°	€
6	L	ESVL 6	12,63
8	L	ESVL 8	13,08
10	L	ESVL 10	11,44
12	L	ESVL 12	14,88
15	L	ESVL 15	15,77
18	L	ESVL 18	21,06
22	L	ESVL 22	27,56
28	L	ESVL 28	36,10
35	L	ESVL 35	49,31
42	L	ESVL 42	71,33
6	S	ESVS 6	12,78
8	S	ESVS 8	13,60
10	S	ESVS 10	14,88
12	S	ESVS 12	15,53
16	S	ESVS 16	23,05
20	S	ESVS 20	29,36
25	S	ESVS 25	39,23
30	S	ESVS 30	49,38
38	S	ESVS 38	75,73

Racores DIN 2353

Raccords à bague DIN 2353
DIN 2353 Pipe fittings
Raccordi ad anello DIN 2353

Pipe

DIN 2353 Pipe Fittings

Gas tube fittings

JIC 37° fittings

SAE Flanges

Clamps

Machines for
processing rigid pipes

Racor recto pasatabiques con tuerca



Union double passe cloison
Straight bulkhead coupling
Raccordo passaparete

TUBO PIPE	S.	REF. PART N°	€	REFERENCIA STA PART N° STA	€
6	6	L SVL 6	3,90	STA SVL 6	3,10
8	8	L SVL 8	4,03	STA SVL 8	2,48
10	10	L SVL 10	4,89	STA SVL 10	2,81
12	12	L SVL 12	5,63	STA SVL 12	3,51
15	15	L SVL 15	8,54	STA SVL 15	5,54
18	18	L SVL 18	13,73	STA SVL 18	11,26
22	22	L SVL 22	17,58	STA SVL 22	14,12
28	28	L SVL 28	26,91	STA SVL 28	20,48
35	35	L SVL 35	41,95	STA SVL 35	34,31
42	42	L SVL 42	56,20	STA SVL 42	48,01
6	6	S SVS 6	5,18	STA SVS 6	4,45
8	8	S SVS 8	5,58	STA SVS 8	4,87
10	10	S SVS 10	6,46	STA SVS 10	5,41
12	12	S SVS 12	8,60	STA SVS 12	5,78
14	14	S SVS 14	14,24	STA SVS 14	13,41
16	16	S SVS 16	13,86	STA SVS 16	7,92
20	20	S SVS 20	21,74	STA SVS 20	17,77
25	25	S SVS 25	34,93	STA SVS 25	27,68
30	30	S SVS 30	42,83	STA SVS 30	34,20
38	38	S SVS 38	69,03	STA SVS 38	57,44

Racor en codo pasatabiques con tuerca

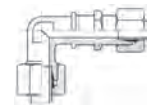

Coude égal passe cloison
Elbow bulkhead coupling
Raccordo passaparete a 90°

TUBO PIPE	SERIE	REFERENCIA PART N°	€
6	6	L USVL 6	8,46
8	8	L USVL 8	8,77
10	10	L USVL 10	9,72
12	12	L USVL 12	11,72
15	15	L USVL 15	14,20
18	18	L USVL 18	20,24
22	22	L USVL 22	31,71
28	28	L USVL 28	48,94
35	35	L USVL 35	71,85
42	42	L USVL 42	101,89
8	8	S USVS 8	10,70
10	10	S USVS 10	13,44
12	12	S USVS 12	13,89
14	14	S USVS 14	24,19
16	16	S USVS 16	20,13
20	20	S USVS 20	31,60
25	25	S USVS 25	51,44
30	30	S USVS 30	71,28
38	38	S USVS 38	105,89

Racor recto hembra rosca BSP



Union simple femelle gaz
Female stud coupling
Raccordo diritto femmina BSP

T. P.	S.	ROSCA THREAD	REFERENCIA PART N°	€	REFERENCIA STA PART N° STA	€
6	L	1/8" BSP	GAIL 6 R 1/8	2,30	STA GAIL 6 R 1/8	1,65
8	L	1/4" BSP	GAIL 8 R 1/4	2,47	STA GAIL 8 R 1/4	1,77
10	L	1/4" BSP	GAIL 10 R 1/4	2,69	STA GAIL 10 R 1/4	1,90
10	L	3/8" BSP	GAIL 10 R 3/8	13,71	STA GAIL 10 R 3/8	12,92
10	L	1/2" BSP	GAIL 10 R 1/2	18,82	STA GAIL 10 R 1/2	18,05
12	L	3/8" BSP	GAIL 12 R 3/8	3,29	STA GAIL 12 R 3/8	2,33
12	L	1/2" BSP	GAIL 12 R 1/2	11,52	STA GAIL 12 R 1/2	10,57
15	L	1/2" BSP	GAIL 15 R 1/2	4,55	STA GAIL 15 R 1/2	3,29
18	L	1/2" BSP	GAIL 18 R 1/2	6,03	STA GAIL 18 R 1/2	3,90
22	L	3/4" BSP	GAIL 22 R 3/4	8,94	STA GAIL 22 R 3/4	6,06
28	L	1" BSP	GAIL 28 R 1	22,91	STA GAIL 28 R 1	18,03
35	L	1 1/4" BSP	GAIL 35 R 1 1/4	35,80	STA GAIL 35 R 1 1/4	29,36
42	L	1 1/2" BSP	GAIL 42 R 1 1/2	39,32	STA GAIL 42 R 1 1/2	31,95
6	S	1/4" BSP	GAIS 6 R 1/4	4,51	STA GAIS 6 R 1/4	3,82
8	S	1/4" BSP	GAIS 8 R 1/4	4,61	STA GAIS 8 R 1/4	3,87
10	S	3/8" BSP	GAIS 10 R 3/8	6,33	STA GAIS 10 R 3/8	5,40
14	S	1/2" BSP	GAIS 14 R 1/2	12,18	STA GAIS 14 R 1/2	10,37
16	S	1/2" BSP	GAIS 16 R 1/2	8,30	STA GAIS 16 R 1/2	6,05
20	S	3/4" BSP	GAIS 20 R 3/4	13,68	STA GAIS 20 R 3/4	10,48
25	S	1" BSP	GAIS 25 R 1	26,76	STA GAIS 25 R 1	21,24
30	S	1 1/4" BSP	GAIS 30 R 1 1/4	36,35	STA GAIS 30 R 1 1/4	29,44
38	S	1 1/2" BSP	GAIS 38 R 1 1/2	43,18	STA GAIS 38 R 1 1/2	33,48

Racor recto hembra rosca Métrica

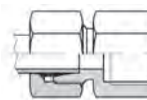

Union simple femelle Métrique
Female stud coupling Metric cyl
Raccordo diritto femmina Metrico

TUBO PIPE	SERIE	ROSCA THREAD	REFERENCIA PART N°	€
6	L	M10x1	GAIL 6 M 10X1	7,48
8	L	M12x1,5	GAIL 8 M 12X1.5	8,73
10	L	M14X1.5	GAIL 10 M14X1.5	9,20
12	L	M16X1.5	GAIL 12 M16X1.5	11,23
15	L	M18X1.5	GAIL 15 M18X1.5	11,60
18	L	M22X1.5	GAIL 18 M22X1.5	14,49
22	L	M26X1.5	GAIL 22 M26X1.5	18,59
6	S	M12x1,5	GAIS 6 M 12X1.5	9,94
8	S	M14x1,5	GAIS 8 M 14X1.5	11,02
10	S	M16X1.5	GAIS 10 M16X1.5	14,11
12	S	M18X1.5	GAIS 12 M18X1.5	14,24
14	S	M20X1.5	GAIS 14 M20X1.5	22,82
20	S	M27x2	GAIS 20 M 27X2	25,10

Racores DIN 2353

Raccords à bague DIN 2353
DIN 2353 Pipe fittings
Raccordi ad anello DIN 2353

Racor para manómetro BSP



Union pour manomètre gaz
Gauge coupling BSP cyl
Raccordo per manometri BSP

TUBO PIPE	SERIE	ROSCA THREAD	REFERENCIA PART N°	€
6	L	1/4" BSP	MAVL 6 R 1/4	3,23
8	L	1/4" BSP	MAVL 8 R 1/4	3,28
10	L	1/4" BSP	MAVL 10 R 1/4	3,62
12	L	1/4" BSP	MAVL 12 R 1/4	3,97
6	S	1/2" BSP	MAVS 6 R 1/2	5,73
8	S	1/2" BSP	MAVS 8 R 1/2	5,81
10	S	1/2" BSP	MAVS 10 R 1/2	6,09
12	S	1/2" BSP	MAVS 12 R 1/2	6,24

Arandela para manómetros

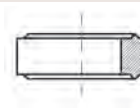

Bague pour manomètres
Seal for gauge coupling
Guarnizioni per manometri

ROSCA THREAD	REFERENCIA PART N°	€
1/4" BSP	AM 1/4	1,32
1/2" BSP	AM 1/2	1,36

Racor en codo orientable sin estrangulador rosca BSP



Equerre orientable sans étrangleur gaz BSP (passage total)
Banjo coupling with captive seal and o-ring BSP cyl
Raccordo orientabile a 90° ad occhio BSP con guarnizione

T. P.	S.	ROSCA THREAD	REFERENCIA PART N°	€	REFERENCIA STA PART N° STA	€
4	LL	1/8" BSP	WSVLL 4 R 1/8	10,49	STA WSVLL 4 R 1/8	9,85
6	LL	1/8" BSP	WSVLL 6 R 1/8	10,28	STA WSVLL 6 R 1/8	9,65
8	LL	1/8" BSP	WSVLL 8 R 1/8	10,16	STA WSVLL 8 R 1/8	9,70
6	L	1/8" BSP	WSVL 6 R 1/8	11,29	STA WSVL 6 R 1/8	10,67
8	L	1/4" BSP	WSVL 8 R 1/4	12,20	STA WSVL 8 R 1/4	13,48
10	L	1/4" BSP	WSVL 10 R 1/4	12,22	STA WSVL 10 R 1/4	8,45
12	L	3/8" BSP	WSVL 12 R 3/8	15,82	STA WSVL 12 R 3/8	12,36
15	L	1/2" BSP	WSVL 15 R 1/2	19,07	STA WSVL 15 R 1/2	21,27
18	L	1/2" BSP	WSVL 18 R 1/2	25,04	STA WSVL 18 R 1/2	22,90
22	L	3/4" BSP	WSVL 22 R 3/4	38,68	STA WSVL 22 R 3/4	35,80
28	L	1" BSP	WSVL 28 R 1	61,42	STA WSVL 28 R 1	56,54
35	L	1"1/4 BSP	WSVL 35 R 1 1/4	92,97	STA WSVL 35 R 1 1/4	86,09
42	L	1"1/2 BSP	WSVL 42 R 1 1/2	122,05	STA WSVL 42 R 1 1/2	114,63
6	S	1/4" BSP	WSVS 6 R 1/4	12,20	STA WSVS 6 R 1/4	11,51
8	S	1/4" BSP	WSVS 8 R 1/4	12,65	STA WSVS 8 R 1/4	11,92
10	S	3/8" BSP	WSVS 10 R 3/8	16,17	STA WSVS 10 R 3/8	15,21
12	S	3/8" BSP	WSVS 12 R 3/8	16,35	STA WSVS 12 R 3/8	15,24
14	S	1/2" BSP	WSVS 14 R 1/2	22,17	STA WSVS 14 R 1/2	20,35
16	S	1/2" BSP	WSVS 16 R 1/2	25,10	STA WSVS 16 R 1/2	21,17
20	S	3/4" BSP	WSVS 20 R 3/4	40,15	STA WSVS 20 R 3/4	32,50
25	S	1" BSP	WSVS 25 R 1	62,54	STA WSVS 25 R 1	57,01
30	S	1"1/4 BSP	WSVS 30 R 1 1/4	96,19	STA WSVS 30 R 1 1/4	89,23
38	S	1"1/2 BSP	WSVS 38 R 1 1/2	128,83	STA WSVS 38 R 1 1/2	119,07

Racor en codo orientable sin estrangulador rosca Métrica

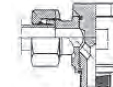

Equerre orientable sans étrangleur métrique (passage total)
Banjo coupling with captive seal and o-ring metric cyl
Raccordo orientabile a 90° ad occhio Metrico con guarnizione

TUBO PIPE	SERIE	ROSCA THREAD	REFERENCIA PART N°	€
6	LL	M10X1	WSVLL 6 M 10X1	11,30
8	LL	M10X1	WSVLL 8 M 10X1	11,18
6	L	M10X1	WSVL 6 M 10X1	12,27
8	L	M12X1.5	WSVL 8 M 12X1.5	13,08
10	L	M14X1.5	WSVL 10 M 14X1.5	13,62
12	L	M16X1.5	WSVL 12 M 16X1.5	16,92
15	L	M18X1.5	WSVL 15 M 18X1.5	19,76
18	L	M22X1.5	WSVL 18 M 22X1.5	27,60
22	L	M26X1.5	WSVL 22 M 26X1.5	40,17
28	L	M33X2	WSVL 28 M 33X2	66,56
35	L	M42X2	WSVL 35 M 42X2	101,03
42	L	M48X2	WSVL 42 M 48X2	132,90
6	S	M12X1.5	WSVS 6 M 12X1.5	13,37
8	S	M14X1.5	WSVS 8 M 14X1.5	13,82
10	S	M16X1.5	WSVS 10 M 16X1.5	17,31
12	S	M18X1.5	WSVS 12 M 18X1.5	19,29
16	S	M22X1.5	WSVS 16 M 22X1.5	28,68
20	S	M27X2	WSVS 20 M 27X2	43,94
25	S	M33X2	WSVS 25 M 33X2	67,75
30	S	M42X2	WSVS 30 M 42X2	104,49
38	S	M48x2	WSVS 38 M 48X2	140,26

Racores DIN 2353

Raccords à bague DIN 2353
DIN 2353 Pipe fittings
Raccordi ad anello DIN 2353

Pipe

DIN 2353 Pipe Fittings

Gas tube fittings

JIC 37° fittings

SAE Flanges

Clamps

Machines for processing rigid pipes

Tapón de cierre para tubo



Bouchon de fermeture avec o'ring
Blanking plug with o'ring
Tappo di chiusura con o'ring

TUBO PIPE	SERIE	REFERENCIA PART N°	€
6	L/S	BUTZEN L 6	0,70
8	L/S	BUTZEN L 8	0,86
10	L/S	BUTZEN L 10	0,92
12	L/S	BUTZEN L 12	1,10
15	L	BUTZEN L 15	1,47
18	L	BUTZEN L 18	1,60
22	L	BUTZEN L 22	2,53
28	L	BUTZEN L 28	4,23
35	L	BUTZEN L 35	8,31
42	L	BUTZEN L 42	12,86
14	S	BUTZEN S 14	2,78
16	S	BUTZEN S 16	1,57
20	S	BUTZEN S 20	2,38
25	S	BUTZEN S 25	3,36
30	S	BUTZEN S 30	5,86
38	S	BUTZEN S 38	10,79

Tapón de cierre Allen rosca Métrica con junta



Bouchon Allen Métrique avec o'ring
Blanking plug with captive seal etric cyl
Tappo cilindrico Metrico esagono incassato con guarnizione

ROSCA THREAD	REFERENCIA PART N°	€
M10X1	STOPFEN M 10X1	1,44
M12X1.5	STOPFEN M 12X1.5	1,89
M14X1.5	STOPFEN M 14X1.5	2,06
M16X1.5	STOPFEN M 16X1.5	2,44
M18X1.5	STOPFEN M 18X1.5	2,42
M22X1.5	STOPFEN M 22X1.5	3,09
M26X1.5	STOPFEN M 26X1.5	4,57
M27X2	STOPFEN M 27X2	4,04
M33X2	STOPFEN M 33X2	5,36
M42X2	STOPFEN M 42X2	7,74
M48X2	STOPFEN M 48X2	10,63

Tapón



Bouchon
Plug
Tappo

TUBO PIPE	SERIE	ROSCA THREAD	REFERENCIA PART N°	€
6	L	12x1.5	STA TML 6	1,35
8	L	14x1.5	STA TML 8	1,58
10	L	16x1.5	STA TML 10	1,87
12	L	18x1.5	STA TML 12	2,20
15	L	22x1.5	STA TML 15	3,10
18	L	26x1.5	STA TML 18	4,68
22	L	30x2	STA TML 22	6,58
28	L	36x2	STA TML 28	12,33
35	L	45x2	STA TML 35	20,54
42	L	52x2	STA TML 42	28,62
6	S	14x1.5	STA TMS 6	1,60
8	S	16x1.5	STA TMS 8	1,91
10	S	18x1.5	STA TMS 10	2,26
12	S	20x1.5	STA TMS 12	2,65
14	S	22x1.5	STA TMS 14	4,82
16	S	24x1.5	STA TMS 16	4,96
20	S	30x2	STA TMS 20	7,47
25	S	36x2	STA TMS 25	13,03
30	S	42x2	STA TMS 30	19,87
38	S	52x2	STA TMS 38	28,98

Tapón de cierre Allen rosca BSP con junta



Bouchon Allen gaz avec o'ring
Blanking plug with captive seal BSP cyl
Tappo cilindrico BSP esagono incassato con o'ring

ROSCA THREAD	REFERENCIA PART N°	€
1/8"BSP	STOPFEN 1/8	0,98
1/4"BSP	STOPFEN 1/4	1,08
3/8"BSP	STOPFEN 3/8	1,52
1/2"BSP	STOPFEN 1/2	1,81
3/4"BSP	STOPFEN 3/4	2,74
1"BSP	STOPFEN 1	5,27
1"1/4 BSP	STOPFEN 1 1/4	8,92
1"1/2 BSP	STOPFEN 1 1/2	10,43
2" BSP	STOPFEN 2	22,70

Racores DIN 2353

Raccords à bague DIN 2353
DIN 2353 Pipe fittings
Raccordi ad anello DIN 2353

Antirretorno tubo-tubo

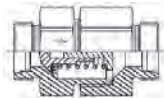

Clapet antiretour bidirectional tube-tube

Non-return valve tube-tube

Valvola di ritegno tubo-tubo

TUBO PIPE	SERIE	REFERENCIA PART N°	€
6	L	RHDL 6	14,20
8	L	RHDL 8	14,83
10	L	RHDL 10	17,98
12	L	RHDL 12	22,63
15	L	RHDL 15	29,44
18	L	RHDL 18	39,09
22	L	RHDL 22	62,62
28	L	RHDL 28	88,77
35	L	RHDL 35	114,15
42	L	RHDL 42	129,96
6	S	RHDS 6	18,95
8	S	RHDS 8	19,53
10	S	RHDS 10	23,42
12	S	RHDS 12	24,75
14	S	RHDS 14	41,96
16	S	RHDS 16	39,71
20	S	RHDS 20	64,35
25	S	RHDS 25	79,55
30	S	RHDS 30	99,73
38	S	RHDS 38	127,25

Antirretorno tubo - rosca BSP

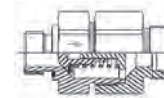

Clapet antiretour unidir. a droite tube-mâle BSP

Non-return valve flow towards male stud end BSP cyl

Valvola di ritegno a destra

TUBO PIPE	SERIE	ROSCA THREAD	REFERENCIA PART N°	€
6	L	1/8" BSP	RHZL 6 R 1/8	13,56
8	L	1/4" BSP	RHZL 8 R1/4	14,98
10	L	1/4" BSP	RHZL 10 R1/4	18,16
12	L	3/8" BSP	RHZL 12 R3/8	22,40
15	L	1/2" BSP	RHZL 15 R1/2	28,02
18	L	1/2" BSP	RHZL 18 R1/2	38,57
22	L	3/4" BSP	RHZL 22 R 3/4	62,03
28	L	1" BSP	RHZL 28 R1	89,54
35	L	1"1/4 BSP	RHZL 35 R1 1/4	115,42
42	L	1"1/2 BSP	RHZL 42 R1 1/2	126,22
6	S	1/4" BSP	RHZS 6 R 1/4	19,09
8	S	1/4" BSP	RHZS 8 R1/4	19,29
10	S	3/8" BSP	RHZS 10 R 3/8	23,32
12	S	3/8" BSP	RHZS 12 R3/8	24,63
14	S	1/2" BSP	RHZS 14 R 1/2	43,43
16	S	1/2" BSP	RHZS 16 R1/2	39,13
20	S	3/4" BSP	RHZS 20 R3/4	62,62
25	S	1" BSP	RHZS 25 R1	75,45
30	S	1"1/4 BSP	RHZS 30 R1 1/4	99,43
38	S	1"1/2 BSP	RHZS 38 R1 1/2	124,85

Antirretorno rosca BSP - tubo



Clapet antiretour unidir. a gauche mâle BSP-tube

Non-return valve flow from male stud end BSP cyl

Valvola di ritegno a sinistra

TUBO PIPE	SERIE	ROSCA THREAD	REFERENCIA PART N°	€
6	L	1/8" BSP	RHVL 6 R1/8	13,70
8	L	1/4" BSP	RHVL 8 R 1/4	15,08
10	L	1/4" BSP	RHVL 10 R 1/4	18,24
12	L	3/8" BSP	RHVL 12 R3/8	22,48
15	L	1/2" BSP	RHVL 15 R 1/2	28,16
18	L	1/2" BSP	RHVL 18 R1/2	38,75
22	L	3/4" BSP	RHVL 22 R3/4	62,22
28	L	1" BSP	RHVL 28 R1	89,82
35	L	1"1/4 BSP	RHVL 35 R1 1/4	115,71
42	L	1"1/2 BSP	RHVL 42 R1 1/2	126,56
6	S	1/4" BSP	RHVS 6 R1/4	19,03
8	S	1/4" BSP	RHVS 8 R1/4	19,39
10	S	3/8" BSP	RHVS 10 R3/8	23,43
12	S	3/8" BSP	RHVS 12 R3/8	24,78
14	S	1/2" BSP	RHVS 14 R 1/2	41,02
16	S	1/2" BSP	RHVS 16 R1/2	39,29
20	S	3/4" BSP	RHVS 20 R3/4	62,80
25	S	1" BSP	RHVS 25 R1	75,67
30	S	1"1/4 BSP	RHVS 30 R1 1/4	99,69
38	S	1"1/2 BSP	RHVS 38 R 1 1/2	125,19

Racores para tubo gas

Raccords tube gaz

Gas tube fittings

Raccordi per tubo gas

3

Racores para tubo gas

Raccords tube gaz | Gas tube fittings | Raccordi per tubo gas

146

Racores para tubo gas

Raccords tube gaz | Gas tube fittings | Raccordi per tubo gas

Pipe

DIN 2353 Pipe Fittings

Gas tube fittings

JIC 37° fittings

SAE Flanges

Clamps

Machines for processing rigid pipes

▶ Tuercas y anillos | Écrous et bagues | Nuts and cutting rings | Dadi e anelli

147



ML/MS



ACL

▶ Uniones tubo-tubo | Unions doubles | Straight couplings | Raccordi intermedi

147

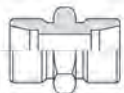

STA DL

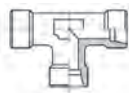

STA TL

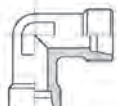

STA EL



STA KVL

▶ Uniones tubo-rosca | Unions simples mâle | Male stud couplings | Raccordi di estremità

148



STA AKL R



STA CKL R



STA AL R

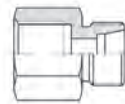

STA GAIL R

Racores para tubo gas

Raccords tube gaz
Gas tube fittings
Raccordi per tubo gas

Tuercas gas



Écrou gaz
Nut gas
Dado gas

TUBO PIPE	ROSCA THREAD	REFERENCIA PART N°	€
1/4" - 13.2	20X1,5	ML 13.2	3,95
3/8" - 16.7	24X1,5	ML 16.7	4,94
1/2" - 21.3	30X1,5	ML 21.3	8,01
3/4" - 26.7	36X1,5	ML 26.7	14,92
1" - 33.5	45X1,5	ML 33.5	27,46
1"1/4 - 42.4	52X1,5	ML 42.4	40,66

Anillo tubo gas



Bague tube gaz
Cutting ring gas
Anello tubo-gas

TUBO PIPE	REFERENCIA PART N°	€
1/4" - 13.2	ACL 13.2	1,82
3/8" - 16.7	ACL 16.7	2,60
1/2" - 21.3	ACL 21.3	3,59
3/4" - 26.7	ACL 26.7	6,08
1" - 33.5	ACL 33.5	9,62
1" 1/4 - 42.4	ACL 42.4	15,08

Unión recta tubo-tubo



Union double
Straight coupling
Raccordo tubo-tubo

TUBO PIPE	SERIE	REFERENCIA PART N°	€
13.2	L	STA DL 13.2	9,31
16.7	L	STA DL 16.7	11,08
21.3	L	STA DL 21.3	20,90
26.7	L	STA DL 26.7	26,26
33.5	L	STA DL 33.5	52,57
42.4	L	STA DL 42.4	90,06

Unión en codo tubo-tubo



Coude égal
Equal elbow coupling
Raccordo a 90° tubo-tubo

TUBO PIPE	SERIE	REFERENCIA PART N°	€
13.2	L	STA EL 13.2	18,10
16.7	L	STA EL 16.7	20,54
21.3	L	STA EL 21.3	33,75
26.7	L	STA EL 26.7	54,55
33.5	L	STA EL 33.5	115,65
42.4	L	STA EL 42.4	202,18

Unión en T tubo-tubo

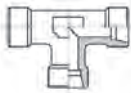

TÉ Égal
Equal TEE
Raccordo a T tubo-tubo

TUBO PIPE	SERIE	REFERENCIA PART N°	€
13.2	L	STA TL 13.2	22,26
16.7	L	STA TL 16.7	25,95
21.3	L	STA TL 21.3	42,02
26.7	L	STA TL 26.7	48,98
33.5	L	STA TL 33.5	146,80

Unión en cruz tubo-tubo



Croix égale
Equal cross
Raccordo a croce tubo-tubo

TUBO PIPE	SERIE	REFERENCIA PART N°	€
16.7	L	STA KVL 16.7	115,44

Racores para tubo gas

Raccords tube gaz
Gas tube fittings
Raccordi per tubo gas

Pipe

DIN 2353 Pipe Fittings

Gas tube fittings

JIC 37° fittings

SAE Flanges

Clamps

Machines for processing rigid pipes

Unión recta tubo-rosca cónica BSPT



Union mâle gaz conique

Straight male stud coupling tapered
Raccordo diritto conico per tubo gas

TUBO PIPE	S.	ROSCA THREAD	REFERENCIA PART N°	€
13.2	L	1/2" BSPT	STA AKL 13.2 R 1/2	9,98
16.7	L	1/4" BSPT	STA AKL 16.7 R 1/4	17,00
16.7	L	3/8" BSPT	STA AKL 16.7 R 3/8	10,92
16.7	L	1/2" BSPT	STA AKL 16.7 R 1/2	12,17
21.3	L	1/2" BSPT	STA AKL 21.3 R 1/2	16,33
21.3	L	3/4" BSPT	STA AKL 21.3 R 3/4	16,33
26.7	L	3/4" BSPT	STA AKL 26.7 R 3/4	28,03
26.7	L	1" BSPT	STA AKL 26.7 R 1	54,18
33.5	L	1" BSPT	STA AKL 33.5 R 1	74,31
42.4	L	1 1/4" BSPT	STA AKL 42.4 R 1 1/4	115,96

Unión en codo tubo-rosca cónica BSPT



Coude mâle gaz conique

Male stud elbow BSPT
Raccordo a 90° conico per tubo gas

TUBO PIPE	S.	ROSCA THREAD	REFERENCIA PART N°	€
13.2	L	1/4" BSPT	STA CKL 13.2 R 1/4	17,11
13.2	L	3/8" BSPT	STA CKL 13.2 R 3/8	17,11
16.7	L	3/8" BSPT	STA CKL 16.7 R 3/8	20,85
21.3	L	1/2" BSPT	STA CKL 21.3 R 1/2	39,99
26.7	L	3/4" BSPT	STA CKL 26.7 R 3/4	61,15
33.5	L	1" BSPT	STA CKL 33.5 R 1	157,82
42.4	L	1 1/4" BSPT	STA CKL 42.4 R 1 1/4	317,15

Unión recta tubo-rosca cilíndrica BSP



Union mâle gaz cyl

Straight male stud coupling cyl
Raccordo diritto cilindrico per tubo gas

TUBO PIPE	SERIE	ROSCA THREAD	REFERENCIA PART N°	€
13.2	L	1/4" BSP	STA AL 13.2 R 1/4	8,53
13.2	L	3/8" BSP	STA AL 13.2 R 3/8	8,53
16.7	L	3/8" BSP	STA AL 16.7 R 3/8	10,56
16.7	L	1/2" BSP	STA AL 16.7 R 1/2	7,26
21.3	L	1/2" BSP	STA AL 21.3 R 1/2	16,43
26.7	L	3/4" BSP	STA AL 26.7 R 3/4	22,78
42.4	L	1 1/4" BSP	STA AL 42.4 R 1 1/4	100,00
42.4	L	1 1/2" BSP	STA AL 42.4 R 1 1/2	125,32

Unión recta tubo-hembra fija BSP

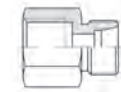

Union femelle gaz cyl

Female stud coupling gas
Raccordo diritto femmina per tubo gas

TUBO PIPE	SERIE	ROSCA THREAD	REFERENCIA PART N°	€
13.2	L	3/8" BSP	STA GAIL 13.2 R 3/8	16,33
13.2	L	1/2" BSP	STA GAIL 13.2 R 1/2	16,28

Atención | Attention | Warning | Attenzione

- Una correcta lubricación garantiza el buen funcionamiento de las roscas.
No lo olvide
- Une correcte lubrification vous garanti l'utilisation correcte des filetages.
Ne l'oubliez pas
- A correct lubricating guarantee you a correct use of the threads.
Do not forget it
- Una corretta lubrificazione vi garantisce un corretto utilizzo delle filettature.
Non dimenticatelo



Racores JIC 37°

Raccords JIC 37°
JIC 37° fittings
Raccordi JIC 37°

4

Racores JIC 37°

Raccords JIC 37° | JIC 37° fittings | Raccordi JIC 37°

152

Racores JIC 37°

Raccords JIC 37° | JIC 37° fittings | Raccordi JIC 37°

Pipe

Tuercas y férulas JIC 37° | Écrous et Ferrules JIC 37° | Nuts and Sleeves | Dadi e Bussole JIC 37°

155



S110

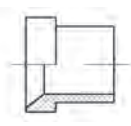

S120

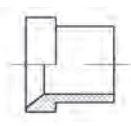

S120-W

DIN 2353 Pipe Fittings

Tapones JIC 37° | Bouchons JIC 37° | JIC 37° Plugs | Tappi JIC 37°

155



S130

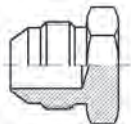

S140

Gas tube fittings

Uniones rectas JIC 37° | Unions droïtes JIC 37° | JIC 37° Straight union | Adattatori diritti JIC 37°

156



S260



S730



S200



S230



S210



S220



S250



S240

JIC 37° fittings

Uniones macho-hembra JIC 37° | Unions mâle JIC 37° x femelle JIC 37° | JIC 37° Male-female unions | Adattatori maschio-femmina JIC 37°

158

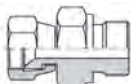

S180



S290



S280



S150

SAE Flanges

Codos JIC 37° | Coudes JIC 37° | JIC 37° Elbows | Adattatori a 45° e 90° JIC 37°

159



S500



S650



S550



S675



S525



S690

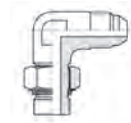

S600

Clamps



S615

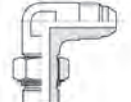

S575

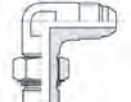

S625

Machines for processing rigid pipes

Tes y Cruz JIC 37° | Tés et Croix JIC 37° | JIC 37° Tees and Crosses | Adattatori a T e Croci JIC 37°

161



S505



S680



S685

► **Tes orientable JIC 37°** | T orientables JIC 37° | JIC 37° Banjo Tees | Adattatori a T orientabili

161



S610



S585

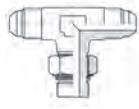

S635



S605



S580



S630

Pipe

DIN 2353 Pipe Fittings

Gas tube fittings

JIC 37° fittings

SAE Flanges

Clamps

Machines for processing rigid pipes

Racores JIC 37°

Raccords JIC 37°
JIC 37° fittings
Raccordi JIC 37°

Tuercas JIC 37°



Écrous JIC 37°
JIC 37° Nuts
Dado JIC 37°

TUBO PIPE	ROSCA THREAD	REFERENCIA PART N°	€
6	7/16" 20h UNF	S11006	0,65
8	1/2" 20h UNF	S11008	0,80
10	9/16" 18h UNF	S11010	0,87
12	3/4" 16h UNF	S11012	1,16
16	7/8" 14h UNF	S11016	1,30
20	1" 1/16 12h UNF	S11020	2,24
25	1" 5/16 12h UNF	S11025	3,32
32	1" 5/8 12h UNF	S11032	6,86
38	1" 7/8 12h UNF	S11038	10,62

Férulas JIC 37° (Tubo Gas)

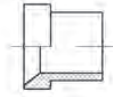

Ferrules JIC 37° pour tube Gaz
37° JIC sleeves Gas tube
Bussola JIC 37° (tubo Gas)

TUBO PIPE	REFERENCIA PART N°	€
1/4	S12006W	0,47
5/16	S12008W	0,55
3/8	S12010W	0,61
1/2	S12012W	0,70
5/8	S12016W	1,02
3/4	S12018W	1,60
1	S12025W	2,39
1 1/4	S12032W	4,75
1 1/2	S12038W	10,20

Férulas JIC 37° (Tubo métrico)



Ferrules JIC 37° pour tube Métrique
JIC 37° sleeves Metric tube
Bussola JIC 37° (tubo Metrico)

TUBO PIPE	REFERENCIA PART N°	€
6	S12006	0,47
8	S12008	0,55
10	S12010	0,61
12	S12012	0,70
14	S12014	1,05
15	S12015	1,08
16	S12016	1,02
18	S12018	1,60
20	S12020	1,57
25	S12025	1,90
30	S12030	4,17
32	S12032	4,75
38	S12038	10,20

Tapón hembra JIC 37°



Obturbateur femelle JIC 37° pour raccord
37° JIC Female plug
Tappo femmina girevole JIC 37°

TUBO PIPE	ROSCA THREAD	REFERENCIA PART N°	€
6	7/16" 20h UNF	S13006	1,17
8	1/2" 20h UNF	S13008	1,67
10	9/16" 18h UNF	S13010	1,75
12	3/4" 16h UNF	S13012	2,34
14-15-16	7/8" 14h UNF	S13016	3,01
18-20	1" 1/16 12h UNF	S13020	4,17
25	1" 5/16 12h UNF	S13025	7,10
30-32	1" 5/8 12h UNF	S13032	12,11
38	1" 7/8 12h UNF	S13038	23,63

Tapón macho JIC 37°



Bouchon mâle JIC 37°
37° JIC Male plug
Tappo maschio JIC 37°

TUBO PIPE	ROSCA THREAD	REFERENCIA PART N°	€
6	7/16" 20h UNF	S14006	1,00
8	1/2" 20h UNF	S14008	1,17
10	9/16" 18h UNF	S14010	1,17
12	3/4" 16h UNF	S14012	1,34
14-15-16	7/8" 14h UNF	S14016	1,50
18-20	1" 1/16 12h UNF	S14020	2,59
25	1" 5/16 12h UNF	S14025	3,51
30-32	1" 5/8 12h UNF	S14032	6,26
38	1" 7/8 12h UNF	S14038	24,57

Racores JIC 37°

Raccords JIC 37°
JIC 37° fittings
Raccordi JIC 37°

Racor macho-macho JIC 37°

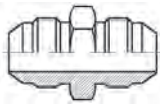

Adapteur droit mâle JIC x mâle JIC
Straight union

Niples di giunzione maschio-maschio JIC 37°

TUBO PIPE		ROSCA THREAD	REFERENCIA PART N°	€
6	1/4	7/16" 20h UNF	S26006	1,01
8	5/16	1/2" 20h UNF	S26008	1,08
10	3/8	9/16" 18h UNF	S26010	1,16
12	1/2	3/4" 16h UNF	S26012	1,37
14-15-16	5/8	7/8" 14h UNF	S26016	2,02
18-20	3/4	1"1/16 12h UNF	S26020	2,67
25	1	1"5/16 12h UNF	S26025	4,70
30-32	1 1/4	1"5/8 12h UNF	S26032	7,58
38	1 1/2	1"7/8 12h UNF	S26038	13,07

Racor hembra giratoria- hembra giratoria JIC 37°

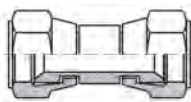

Adapteur femelle tournante JIC x femelle tournante JIC
Straight fitting with crimped nut

Niples femmina-femmina girevole JIC 37°

TUBO PIPE		ROSCA THREAD	REFERENCIA PART N°	€
6	1/4	7/16" 20h UNF	S73006	3,25
8	5/16	1/2" 20h UNF	S73008	5,06
10	3/8	9/16" 18h UNF	S73010	4,19
12	1/2	3/4" 16h UNF	S73012	7,58
14-15-16	5/8	7/8" 14h UNF	S73016	8,16
18-20	3/4	1"1/16 12h UNF	S73020	8,60
25	1	1"5/16 12h UNF	S73025	13,94

Racor macho JIC 37° - macho NPT

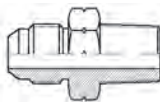

Adapteur mâle JIC x mâle NPT
Straight adaptor male JIC-male NPT

Niples di giunzione JIC 37°-NPT

TUBO PIPE		ROSCA THREAD		REF. PART N°	€
6	1/4	1/8" NPT	7/16" 20h UNF	S2000610	1,01
6	1/4	1/4" NPT	7/16" 20h UNF	S2000613	1,01
8	5/16	1/8" NPT	1/2" 20h UNF	S2000810	2,78
8	5/16	1/4" NPT	1/2" 20h UNF	S2000813	1,23
10	3/8	1/4" NPT	9/16" 18h UNF	S2001013	1,30
10	3/8	3/8" NPT	9/16" 18h UNF	S2001017	1,37
12	1/2	3/8" NPT	3/4" 16h UNF	S2001217	2,02
12	1/2	1/2" NPT	3/4" 16h UNF	S2001221	2,02
12	1/2	3/4" NPT	3/4" 16h UNF	S2001226	7,47
14-15-16	5/8	1/2" NPT	7/8" 14h UNF	S2001621	2,67
14-15-16	5/8	3/4" NPT	7/8" 14h UNF	S2001626	3,47
18-20	3/4	1/2" NPT	1"1/16 12h UNF	S2002021	2,53
18-20	3/4	3/4" NPT	1"1/16 12h UNF	S2002026	5,77
18-20	3/4	1" NPT	1"1/16 12h UNF	S2002033	18,05
25	1	3/4" NPT	1"5/16 12h UNF	S2002526	12,90
25	1	1" NPT	1"5/16 12h UNF	S2002533	5,42
32	1 1/4	1" NPT	1"5/8 12h UNF	S2003233	26,47
32	1 1/4	1"1/4 NPT	1"5/8 12h UNF	S2003242	11,56
38	1 1/2	1"1/4 NPT	1"7/8 12h UNF	S2003842	45,67
38	1 1/2	1"1/2 NPT	1"7/8 12h UNF	S2003848	35,62

Racor macho JIC 37° - macho BSP

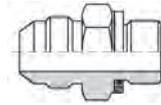

Adapteur mâle JIC x mâle gaz cyl équipé
Straight adaptor male JIC-male BSP

Niples di giunzione JIC37° -BSP

TUBO PIPE		ROSCA THREAD		REF. PART N°	€
6	1/4	1/8" BSP	7/16" 20h UNF	S2300610	0,94
6	1/4	1/4" BSP	7/16" 20h UNF	S2300613	1,14
6	1/4	3/8" BSP	7/16" 20h UNF	S2300617	1,52
8	5/16	1/4" BSP	1/2" 20h UNF	S2300813	1,45
8	5/16	3/8" BSP	1/2" 20h UNF	S2300817	1,59
10	3/8	1/4" BSP	9/16" 18h UNF	S2301013	1,14
10	3/8	3/8" BSP	9/16" 18h UNF	S2301017	1,45
10	3/8	1/2" BSP	9/16" 18h UNF	S2301021	2,53
12	1/2	1/4" BSP	3/4" 16h UNF	S2301213	1,16
12	1/2	3/8" BSP	3/4" 16h UNF	S2301217	1,46
12	1/2	1/2" BSP	3/4" 16h UNF	S2301221	2,02
12	1/2	3/4" BSP	3/4" 16h UNF	S2301226	2,60
14-15-16	5/8	3/8" BSP	7/8" 14h UNF	S2301617	1,52
14-15-16	5/8	1/2" BSP	7/8" 14h UNF	S2301621	2,02
14-15-16	5/8	3/4" BSP	7/8" 14 h UNF	S2301626	3,83
18-20	3/4	1/2" BSP	1"1/16 12h UNF	S2302021	2,96
18-20	3/4	3/4" BSP	1"1/16 12h UNF	S2302026	4,33
18-20	3/4	1" BSP	1"1/16 12h UNF	S2302033	6,00
25	1	3/4" BSP	1"5/16 12h UNF	S2302526	4,70
25	1	1" BSP	1"5/16 12h UNF	S2302533	5,49
25	1	1"1/4 BSP	1"5/16 12h UNF	S2302542	8,45
30-32	1 1/4	1"1/4 BSP	1"5/8 12h UNF	S2303242	9,03
38	1 1/2	1"1/4 BSP	1"7/8 12h UNF	S2303842	10,04
38	1 1/2	1"1/2 BSP	1"7/8 12h UNF	S2303848	20,08

Racor macho JIC 37° - macho BSPT

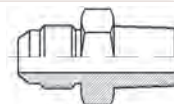

Adapteur mâle JIC x mâle gaz conique
Straight adaptor male JIC-male BSPT

Niples di giunzione JIC 37°-BSPT

TUBO PIPE		ROSCA THREAD		REF. PART N°	€
6	1/4	1/8" BSPT	7/16" 20h UNF	S2100610	0,65
6	1/4	1/4" BSPT	7/16" 20h UNF	S2100613	1,01
8	5/16	1/8" BSPT	1/2" 20h UNF	S2100810	0,80
8	5/16	1/4" BSPT	1/2" 20h UNF	S2100813	0,87
10	3/8	1/4" BSPT	9/16" 18h UNF	S2101013	1,08
10	3/8	3/8" BSPT	9/16" 18h UNF	S2101017	1,16
10	3/8	1/2" BSPT	9/16" 18h UNF	S2101021	1,45
12	1/2	1/4" BSPT	3/4" 16h UNF	S2101213	1,37
12	1/2	3/8" BSPT	3/4" 16h UNF	S2101217	1,73
12	1/2	1/2" BSPT	3/4" 16h UNF	S2101221	1,73
14-15-16	5/8	3/8" BSPT	7/8" 14h UNF	S2101617	2,31
14-15-16	5/8	1/2" BSPT	7/8" 14h UNF	S2101621	2,31
14-15-16	5/8	3/4" BSPT	7/8" 14h UNF	S2101626	2,02
18-20	3/4	1/2" BSPT	1"1/16 12h UNF	S2102021	2,53
18-20	3/4	3/4" BSPT	1"1/16 12h UNF	S2102026	2,75
25	1	3/4" BSPT	1"5/16 12h UNF	S2102526	4,70
25	1	1" BSPT	1"5/16 12h UNF	S2102533	4,48
30-32	1 1/4	1" BSPT	1"5/8 12h UNF	S2103233	9,39
30-32	1 1/4	1 1/4" BSPT	1"5/8 12h UNF	S2103242	21,85
38	1 1/2	1 1/2" BSPT	1"7/8 12h UNF	S2103848	13,58

Racores JIC 37°

Raccords JIC 37°
JIC 37° fittings
Raccordi JIC 37°

Racor macho JIC 37° - macho UNF

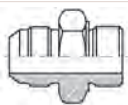

Adaptateur mâle JIC x mâle UNF équipé
Straight adaptor male JIC-male UNF
Niples di giunzione JIC 37°-UNF

TUBO PIPE	ROSCA THREAD	REF. PART N°	€
6	1/4	7/16" 20h JIC 7/16" 20h UNF	S2200611 0,87
6	1/4	7/16" 20h JIC 1/2" 20h UNF	S2200612 1,08
6	1/4	7/16" 20h JIC 9/16" 18h UNF	S2200614 1,01
8	5/16	1/2" 20h JIC 1/2" 20h UNF	S2200812 1,01
10	3/8	9/16" 18h JIC 9/16" 18h UNF	S2201014 1,23
10	3/8	9/16" 18h JIC 3/4" 16h UNF	S2201019 1,45
12	1/2	3/4" 16h JIC 3/4" 16h UNF	S2201219 2,02
12	1/2	3/4" 16h JIC 7/8" 14h UNF	S2201222 2,60
14-15-16	5/8	7/8" 14h JIC 7/8" 14h UNF	S2201622 2,60
14-15-16	5/8	7/8" 14h JIC 1"1/16 12h UNF	S2201627 3,97
18-20	3/4	1"1/16 12h JIC 3/4" 16h UNF	S2202019 3,32
18-20	3/4	1"1/16 12h JIC 7/8" 14h UNF	S2202022 3,47
18-20	3/4	1"1/16 12h JIC 1"1/16 12h UNF	S2202027 4,19
18-20	3/4	1"1/16 12h JIC 1"5/16 12h UNF	S2202033 4,84
25	1	1"5/16 12h JIC 1"1/16 12h UNF	S2202527 9,35
25	1	1"5/16 12h JIC 1"5/16 12h UNF	S2202533 4,48
25	1	1"5/16 12h JIC 1"5/8 12h UNF	S2202541 29,69
30-32	1 1/4	1"5/8 12h JIC 1"5/8 12h UNF	S2203241 9,25
38	1 1/2	1"7/8 12h JIC 1"7/8 12h UNF	S2203848 41,60

Racor pasatabiques JIC 37°

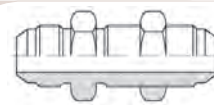

Union passe cloison droit mâle JIC x mâle JIC équipé
Straight bulkhead fitting
Niples passaparete JIC 37°

TUBO PIPE	ROSCA THREAD	REFERENCIA PART N°	€
6	1/4	7/16" 20h UNF	S25006 1,81
8	5/16	1/2" 20h UNF	S25008 2,38
10	3/8	9/16" 18h UNF	S25010 2,67
12	1/2	3/4" 16h UNF	S25012 3,32
14-15-16	5/8	7/8" 14h UNF	S25016 4,19
18-20	3/4	1"1/16 12h UNF	S25020 6,28
25	1	1"5/16 12h UNF	S25025 7,15
30-32	1 1/4	1"5/8 12h UNF	S25032 15,24
38	1 1/2	1"7/8 12h UNF	S25038 52,06

Racor macho JIC 37° - macho Métrico



Adaptateur mâle JIC x mâle Métrique équipé
Metric adaptor male-male JIC
Niples di giunzione JIC 37°-Metrico

TUBO PIPE	ROSCA THREAD	REF. PART N°	€
6	1/4	7/16" 20h UNF M10X1	S2400610 2,17
8	5/16	1/2" 20h UNF M12X1.5	S2400812 2,31
10	3/8	9/16" 18h UNF M14X1.5	S2401014 2,89
12	1/2	3/4" 16h UNF M16X1.5	S2401216 2,46
12	1/2	3/4" 16h UNF M18X1.5	S2401218 2,89
14-15-16	5/8	7/8" 14h UNF M18X1.5	S2401418 3,32
14-15-16	5/8	7/8" 14h UNF M22X1.5	S2401622 3,61
20	3/4	1"1/16 12h UNF M18X1.5	S2402018 5,63
18-20	3/4	1"1/16 12h UNF M22X1.5	S2402022 5,63
18-20	3/4	1"1/16 12h UNF M27X2	S2402027 7,37
25	1	1"5/16 12h UNF M33X2	S2402533 21,58
30-32	1 1/4	1"5/8 12h UNF M42X2	S2403242 29,93

Racores JIC 37°

Raccords JIC 37°
JIC 37° fittings
Raccordi JIC 37°

Pipe

DIN 2353 Pipe Fittings

Gas tube fittings

JIC 37° fittings

SAE Flanges

Clamps

Machines for
processing rigid pipes

Racor macho BSP - hembra giratoria JIC 37°

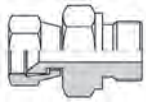

Adaptateur tournante JIC x mâle gaz cyl équipé
Adaptor swivel nut JIC-male BSP
Niples maschio-femmina BSP-JIC 37°

TUBO PIPE		ROSCA THREAD		REF. PART N°	€
6	1/4	M 1/8" BSP	H 7/16" 20h UNF	S1800610	2,84
8	5/16	M 1/4" BSP	H 1/2" 20h UNF	S1800813	3,59
10	3/8	M 1/4" BSP	H 9/16" 18h UNF	S1801013	4,26
10	3/8	M 3/8" BSP	H 9/16" 18h UNF	S1801017	5,26
12	1/2	M 3/8" BSP	H 3/4" 16h UNF	S1801217	5,59
14-15-16	5/8	M 1/2" BSP	H 7/8" 14h UNF	S1801621	7,60
18-20	3/4	M 3/4" BSP	H 1"1/16 12h UNF	S1802026	8,77
25	1	M 1" BSP	H 1"5/16 12h UNF	S1802533	12,69
30-32	1 1/4	M 1"1/4 BSP	H 1"5/8 12h UNF	S1803242	19,87
38	1 1/2	M 1"1/2 BSP	H 1"7/8 12h UNF	S1803848	76,62

Racor macho JIC 37° - hembra fija BSP

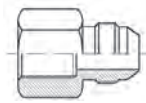

Adaptateur mâle JIC x femelle gaz cyl
Adaptor male JIC 37°-fixed female BSP
Niples maschio-femmina JIC 37°-BSP

TUBO PIPE		ROSCA THREAD		REF. PART N°	€
6	1/4	M 7/16" 20h UNF	H 1/8" BSP	S2800610	4,37
6	1/4	M 7/16" 20h UNF	H 1/4" BSP	S2800613	6,91
8	5/16	M 1/2" 20h UNF	H 1/8" BSP	S2800810	6,62
8	5/16	M 1/2" 20h UNF	H 1/4" BSP	S2800813	4,65
10	3/8	M 9/16" 18h UNF	H 1/4" BSP	S2801013	5,27
10	3/8	M 9/16" 18h UNF	H 3/8" BSP	S2801017	7,39
12	1/2	M 3/4" 16h UNF	H 3/8" BSP	S2801217	6,86
12	1/2	M 3/4" 16h UNF	H 1/2" BSP	S2801221	5,86
14-15-16	5/8	M 7/8" 14h UNF	H 1/2" BSP	S2801621	5,86
18-20	3/4	M 1"1/16 12h UNF	H 1/2" BSP	S2802021	11,88
18-20	3/4	M 1"1/16 12h UNF	H 3/4" BSP	S2802026	12,02
25	1	M 1"5/16 12h UNF	H 1" BSP	S2802533	20,21
30-32	1 1/4	M 1"5/8 12h UNF	H 1"1/4 BSP	S2803242	32,07
38	1 1/2	M 1"7/8 12h UNF	H 1"1/2 BSP	S2803848	59,11

Racor unión macho-hembra JIC 37°

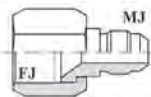

Reducteur mâle JIC x femelle JIC
Reducer adaptor JIC-JIC
Riduzione maschio-femmina JIC 37°

TUBO PIPE		ROSCA THREAD		REF. PART N°	€
10	6	H 9/16" 18h UNF	M 7/16" 20h UNF	S2901006	4,06
12	6	H 3/4" 16h UNF	M 7/16" 20h UNF	S2901206	6,99
8	12	H 3/4" 16h UNF	M 1/2" 20h UNF	S2901208	7,34
12	10	H 3/4" 16h UNF	M 9/16" 18h UNF	S2901210	7,49
14-15-16	6	H 7/8" 14h UNF	M 7/16" 20h UNF	S2901606	8,18
14-15-16	10	H 7/8" 14h UNF	M 9/16" 18h UNF	S2901610	8,95
14-15-16	12	H 7/8" 14h UNF	M 3/4" 16h UNF	S2901612	10,83
18-20	6	H 1"1/16 12h UN	M 7/16" 20h UNF	S2902006	9,51
18-20	12	H 1"1/16 12h UN	M 3/4" 16h UNF	S2902012	8,95
25	18-20	H 1"5/16 12h UN	M 1"1/16 12h UN	S2902520	13,45
30-32	25	H 1"5/8 12h UN	M 1"5/16 12h UN	S2903225	22,03
38	30-32	H 1"7/8 12h UN	M 1"5/8 12h UN	S2903832	29,40

Racor macho BSPT - hembra giratoria JIC 37°

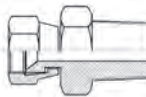

Adaptateur tournante JIC x mâle gaz conique
Adaptor male BSPT-swivel female JIC 37°
Niples maschio-femmina BSPT-JIC 37°

TUBO PIPE		ROSCA THREAD		REF. PART N°	€
6	1/4	M 1/4" BSPT	H 7/16" 20h UNF	S1500613	8,63
8	5/16	M 1/4" BSPT	H 1/2" 20h UNF	S1500813	7,65
10	3/8	M 1/4" BSPT	H 9/16" 18h UNF	S1501013	7,52
12	1/2	M 1/4" BSPT	H 3/4" 16h UNF	S1501213	9,27
12	1/2	M 3/8" BSPT	H 3/4" 16h UNF	S1501217	8,77
16	5/8	M 1/2" BSPT	H 7/8" 14h UNF	S1501621	12,58
20	3/4	M 1/2" BSPT	H 1"1/16 12h UNF	S1502021	14,22
20	3/4	M 3/4" BSPT	H 1"1/16 12h UNF	S1502026	14,54
25	1	M 3/4" BSPT	H 1"5/16 12h UNF	S1502526	33,99
25	1	M 1" BSPT	H 1"5/16 12h UNF	S1502533	27,97
32	1 1/4	M 1"1/4 BSPT	H 1"5/8 12h UNF	S1503242	42,48

Racores JIC 37°

Raccords JIC 37°
JIC 37° fittings
Raccordi JIC 37°

Codo 90° macho - macho JIC 37°



Adaptateur coude 90° mâle JIC 37° x mâle JIC 37°
90° Male elbow male JIC 37°-male JIC 37°
Adattatore a 90° maschio-maschio JIC 37°

TUBO PIPE		ROSCA THREAD	REFERENCIA PART N°	€
6	1/4	7/16" 20h UNF	S50006	2,17
8	5/16	1/2" 20h UNF	S50008	2,53
10	3/8	9/16" 18h UNF	S50010	2,53
12	1/2	3/4" 16h UNF	S50012	3,40
14-15-16	5/8	7/8" 14h UNF	S50016	4,55
18-20	3/4	1"1/16 12h UNF	S50020	7,15
25	1	1"5/16 12h UNF	S50025	9,68
30-32	1 1/4	1"5/8 12h UNF	S50032	35,41
38	1 1/2	1"7/8 12h UNF	S50038	51,27

Codo 90° pasatabiques JIC 37°

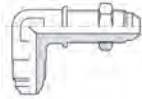

Adaptateur coude 90° passe cloison mâle JIC 37° x mâle JIC 37° équipé
90° Bulkhead coupling male JIC 37°-male JIC 37°
Adattatore a 90° passaparete maschio-maschio JIC 37°

TUBO PIPE		ROSCA THREAD	REFERENCIA PART N°	€
6	1/4	7/16" 20h UNF	S65006	3,32
8	5/16	1/2" 20h UNF	S65008	3,11
10	3/8	9/16" 18h UNF	S65010	3,25
12	1/2	3/4" 16h UNF	S65012	4,41
14-15-16	5/8	7/8" 14h UNF	S65016	6,36
18-20	3/4	1"1/16 12h UNF	S65020	11,05
25	1	1"5/16 12h UNF	S65025	20,80

Codo 90° macho JIC 37° - macho BSPT



Adaptateur coude 90° mâle JIC 37° x mâle gaz conique
90° male elbow male JIC 37° -male BSPT
Adattatore a 90° maschio-maschio JIC 37°-BSPT

TUBO PIPE		ROSCA THREAD		REF. PART N°	€
6	1/4	7/16" 20h UNF	1/8" BSPT	S5500610	9,36
6	1/4	7/16" 20h UNF	1/4" BSPT	S5500613	7,60
8	5/16	1/2" 20h UNF	1/8" BSPT	S5500810	15,04
8	5/16	1/2" 20h UNF	1/4" BSPT	S5500813	7,44
10	3/8	9/16" 18h UNF	1/4" BSPT	S5501013	6,96
10	3/8	9/16" 18h UNF	3/8" BSPT	S5501017	7,84
10	3/8	9/16" 18h UNF	1/2" BSPT	S5501021	16,42
12	1/2	3/4" 16h UNF	1/4" BSPT	S5501213	12,16
12	1/2	3/4" 16h UNF	3/8" BSPT	S5501217	7,97
12	1/2	3/4" 16h UNF	1/2" BSPT	S5501221	10,49
14-15-16	5/8	7/8" 14h UNF	3/8" BSPT	S5501617	12,23
14-15-16	5/8	7/8" 14h UNF	1/2" BSPT	S5501621	9,64
14-15-16	5/8	7/8" 14h UNF	3/4" BSPT	S5501626	18,73
18-20	3/4	1"1/16 12h UNF	1/2" BSPT	S5502021	20,66
18-20	3/4	1"1/16 12h UNF	3/4" BSPT	S5502026	16,55
25	1	1"5/16 12h UNF	3/4" BSPT	S5502526	29,82
25	1	1"5/16 12h UNF	1" BSPT	S5502533	24,73
30-32	1 1/4	1"5/8 12h UNF	1" BSPT	S5503233	34,88
30-32	1 1/4	1"5/8 12h UNF	1 1/4" BSPT	S5503242	35,94
38	1 1/2	1"7/8 12h UNF	1"1/2 BSPT	S5503848	83,92

Codo 90° macho - hembra giratoria JIC 37°



Adaptateur coude 90° mâle JIC 37° x femelle tournante JIC 37°
90° Elbow swivel nut JIC 37°-male JIC 37°
Adattatore a 90° maschio-femmina girevole JIC 37°

TUBO PIPE		ROSCA THREAD	REFERENCIA PART N°	€
6	1/4	7/16" 20h UNF	S67506	2,96
8	5/16	1/2" 20h UNF	S67508	3,83
10	3/8	9/16" 18h UNF	S67510	4,05
12	1/2	3/4" 16h UNF	S67512	5,71
14-15-16	5/8	7/8" 14h UNF	S67516	5,92
18-20	3/4	1"1/16 12h UNF	S67520	7,01
25	1	1"5/16 12h UNF	S67525	15,96
30-32	1 1/4	1"5/8 12h UNF	S67532	56,55
38	1 1/2	1"7/8 12h UNF	S67538	38,50

Codo 90° macho JIC 37° - macho NPT



Adaptateur coude 90° mâle JIC 37° x mâle NPT
90° Male elbow male JIC 37°-male NPT
Adattatore a 90° maschio-maschio JIC 37°-NPT

TUBO PIPE		ROSCA THREAD		REF. PART N°	€
6	1/4	7/16" 20h UNF	1/8" NPT	S5250610	6,70
6	1/4	7/16" 20h UNF	1/4" NPT	S5250613	6,81
8	5/16	1/2" 20h UNF	1/8" NPT	S5250810	5,93
8	5/16	1/2" 20h UNF	1/4" NPT	S5250813	6,57
10	3/8	9/16" 18h UNF	1/4" NPT	S5251013	6,57
10	3/8	9/16" 18h UNF	3/8" NPT	S5251017	6,78
10	3/8	9/16" 18h UNF	1/2" NPT	S5251021	10,67
12	1/2	3/4" 16h UNF	1/4" NPT	S5251213	10,75
12	1/2	3/4" 16h UNF	3/8" NPT	S5251217	7,49
12	1/2	3/4" 16h UNF	1/2" NPT	S5251221	9,08
14-15-16	5/8	7/8" 14h UNF	3/8" NPT	S5251617	11,15
14-15-16	5/8	7/8" 14h UNF	1/2" NPT	S5251621	11,15
14-15-16	5/8	7/8" 14h UNF	3/4" NPT	S5251626	20,47
18-20	3/4	1"1/16 12h UNF	1/2" NPT	S5252021	15,55
18-20	3/4	1"1/16 12h UNF	3/4" NPT	S5252026	12,63
25	1	1"5/16 12h UNF	3/4" NPT	S5252526	23,07
25	1	1"5/16 12h UNF	1" NPT	S5252533	23,12
30-32	1 1/4	1"5/8 12h UNF	1" NPT	S5253233	37,29
30-32	1 1/4	1"5/8 12h UNF	1 1/4" NPT	S5253242	37,29
38	1 1/2	1"7/8 12h UNF	1"1/2 NPT	S5253848	62,13

Codo 45° macho - hembra giratoria JIC 37°



Adaptateur coude 45° mâle JIC 37° x femelle tournante JIC 37°
45° Elbow male-swivel nut JIC 37°
Adattatore a 45° maschio-femmina girevole JIC 37°

TUBO PIPE		ROSCA THREAD	REFERENCIA PART N°	€
6	1/4	7/16" 20h UNF	S69006	3,25
8	5/16	1/2" 20h UNF	S69008	4,12
10	3/8	9/16" 18h UNF	S69010	4,48
12	1/2	3/4" 16h UNF	S69012	5,49
14-15-16	5/8	7/8" 14h UNF	S69016	7,37
18-20	3/4	1"1/16 12h UNF	S69020	9,46
25	1	1"5/16 12h UNF	S69025	15,89

Racores JIC 37°

Raccords JIC 37°
JIC 37° fittings
Raccordi JIC 37°

Pipe

DIN 2353 Pipe Fittings

Gas tube fittings

JIC 37° fittings

SAE Flanges

Clamps

Machines for
processing rigid pipes

Codo 90° macho JIC 37° - macho BSP orient.



Adaptateur orientable coude 90° mâle JIC 37° x mâle gaz cyl + o'ring + bae équipé
90° Banjo elbow male JIC 37°-BSP Banjo male
Adattatore a 90° maschio-maschio orientabile JIC 37°-BSP

TUBO PIPE		ROSCA THREAD		REF. PART N°	€
6	1/4	7/16" 20h UNF	1/8" BSP	S6000610	2,75
6	1/4	7/16" 20h UNF	1/4" BSP	S6000613	3,40
8	5/16	1/2" 20h UNF	1/8" BSP	S6000810	3,25
8	5/16	1/2" 20h UNF	1/4" BSP	S6000813	3,97
10	3/8	9/16" 18h UNF	1/4" BSP	S6001013	3,97
10	3/8	9/16" 18h UNF	3/8" BSP	S6001017	4,19
10	3/8	9/16" 18h UNF	1/2" BSP	S6001021	12,50
12	1/2	3/4" 16h UNF	1/4" BSP	S6001213	4,55
12	1/2	3/4" 16h UNF	3/8" BSP	S6001217	4,84
12	1/2	3/4" 16h UNF	1/2" BSP	S6001221	5,71
16	5/8	7/8" 14h UNF	3/8" BSP	S6001617	6,14
14-15-16	5/8	7/8" 14h UNF	1/2" BSP	S6001621	6,21
18-20	3/4	1"1/16 12h UNF	1/2" BSP	S6002021	8,60
18-20	3/4	1"1/16 12h UNF	3/4" BSP	S6002026	8,38
18-20	3/4	1"1/16 12h UNF	1" BSP	S6002033	13,87
25	1	1"5/16 12h UNF	3/4" BSP	S6002526	13,36
25	1	1"5/16 12h UNF	1" BSP	S6002533	14,95
30-32	1 1/4	1"5/8 12h UNF	1" BSP	S6003233	20,30
30-32	1 1/4	1"5/8 12h UNF	1"1/4 BSP	S6003242	26,51
38	1 1/2	1"7/8 12h UNF	1"1/4 BSP	S6003842	69,94
38	1 1/2	1"7/8 12h UNF	1"1/2 BSP	S6003848	66,63

Codo 45° macho JIC 37° - macho BSP orient.

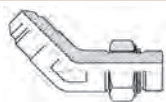

Adaptateur coude 45° mâle JIC 37° x mâle gaz cyl + o'ring et bae équipé
45° Elbow male JIC 37°-BSP Banjo male
Adattatore a 45° maschio-maschio orientabile JIC 37°-maschio BSP orientabile

TUBO PIPE		ROSCA THREAD		REF. PART N°	€
8	5/16	1/2" 20h UNF	1/4" BSP	S6150813	3,47
10	3/8	9/16" 18h UNF	1/4" BSP	S6151013	4,19
12	1/2	3/4" 16h UNF	3/8" BSP	S6151217	5,27
12	1/2	3/4" 16h UNF	1/2" BSP	S6151221	5,85
14-15-16	5/8	7/8" 14h UNF	1/2" BSP	S6151621	5,63
18-20	3/4	1"1/16 12h UNF	1/2" BSP	S6152021	12,28
18-20	3/4	1"1/16 12h UNF	3/4" BSP	S6152026	8,67
25	1	1"5/16 12h UNF	1" BSP	S6152533	14,16

Codo 90° macho JIC 37° - macho UNF orient.



Adaptateur orientable coude 90° mâle JIC 37° x male UNF + o'ring et bae équipé
90° Banjo elbow male JIC 37°-unf Banjo male
Adattatore a 90° maschio-maschio orientabile JIC 37°-UNF

TUBO PIPE		ROSCA THREAD		REF. PART N°	€
6	1/4	7/16" 20h UNF	7/16" 20h UNF	S5750611	2,96
6	1/4	7/16" 20h UNF	1/2" 20h UNF	S5750612	8,40
8	5/16	1/2" 20h UNF	1/2" 20h UNF	S5750812	3,32
10	3/8	9/16" 18h UNF	9/16" 18h UNF	S5751014	4,26
10	3/8	9/16" 18h UNF	3/4" 16h UNF	S5751019	4,70
12	1/2	3/4" 16h UNF	7/8" 14h UNF	S5751222	13,45
14-15-16	5/8	7/8" 14h UNF	3/4" 16h UNF	S5751619	14,35
14-15-16	5/8	7/8" 14h UNF	7/8" 14h UNF	S5751622	7,95
18-20	3/4	1"1/16 12h UNF	7/8" 14h UNF	S5752022	17,06
18-20	3/4	1"1/16 12h UNF	1"1/16 12h UNF	S5752027	9,25
25	1	1"5/16 12h UNF	1"1/16 12h UNF	S5752527	10,89
25	1	1"5/16 12h UNF	1"5/16 12h UNF	S5752533	24,07
30-32	1 1/4	1"5/8 12h UNF	1"5/8 12h UNF	S5753241	47,72
38	1 1/2	1"7/8 12h UNF	1"7/8 12h UNF	S5753848	72,99

Codo 90° macho JIC 37° - macho métrico orient.



Adaptateur orientable coude 90° mâle JIC 37° x mâle Métrique + o'ring et bae équipé
90° Elbow male JIC 37°-Metric Banjo male
Adattatore a 90° maschio-maschio orientabile JIC 37° Metrico

TUBO PIPE		ROSCA THREAD		REFERENCIA PART N°	€
6	1/4	7/16" 20h UNF	M10x1	S6250610	2,89
8	5/16	1/2" 20h UNF	M12x1,5	S6250812	10,41
10	3/8	9/16" 18h UNF	M14x1,5	S6251014	3,90
12	1/2	3/4" 16h UNF	M16x1,5	S6251216	11,73
12	1/2	3/4" 16h UNF	M18x1,5	S6251218	5,20
14-15-16	5/8	7/8" 14h UNF	M18x1,5	S6251618	13,43
14-15-16	5/8	7/8" 14h UNF	M22x1,5	S6251622	7,30
18-20	3/4	1"1/16 12h UNF	M22x1,5	S6252022	10,40
18-20	3/4	1"1/16 12h UNF	M 27x2	S6252027	20,95
25	1	1"5/16 12h UNF	M33x2	S6252533	15,82

Racores JIC 37°

Raccords JIC 37°
JIC 37° fittings
Raccordi JIC 37°

Tes macho-macho-macho JIC 37°

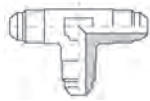

Tés égaux mâle JIC 37°

Union Tee male JIC 37°

Adattatore a T maschio JIC 37°

TUBO PIPE		ROSCA THREAD	REF. PART N°	€
6	1/4	7/16" 20h UNF	S50506	3,32
8	5/16	1/2" 20h UNF	S50508	3,40
10	3/8	9/16" 18h UNF	S50510	4,05
12	1/2	3/4" 16h UNF	S50512	6,14
14-15-16	5/8	7/8" 14h UNF	S50516	7,08
18-20	3/4	1"1/16 12h UNF	S50520	9,10
25	1	1"5/16 12h UNF	S50525	13,65
30-32	1 1/4	1"5/8 12h UNF	S50532	32,36
38	1 1/2	1"7/8 12h UNF	S50538	109,13

Tes macho-hembra giratoria-macho JIC 37°

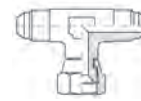

Tés égaux tournantes JIC 37° au centre

Swivel brunch Tee male JIC 37°-swivel nut JIC 37°-male JIC 37°

Adattatore a T maschio-femmina girevole-maschio JIC 37°

TUBO PIPE		ROSCA THREAD	REF. PART N°	€
6	1/4	7/16" 20h UNF	S68506	4,55
8	5/16	1/2" 20h UNF	S68508	4,33
10	3/8	9/16" 18h UNF	S68510	4,33
12	1/2	3/4" 16h UNF	S68512	6,93
14-15-16	5/8	7/8" 14h UNF	S68516	8,60
18-20	3/4	1"1/16 12h UNF	S68520	10,76
25	1	1"5/16 12h UNF	S68525	43,11
30-32	1 1/4	1"5/8 12h UNF	S68532	70,95
38	1 1/2	1"7/8 12h UNF	S68538	106,12

Tes macho-macho-hembra giratoria JIC 37°



Tés égaux tournantes JIC 37° au latéral

Swivel run Tee male JIC 37°-swivel nut JIC 37°

Adattatore a T maschio-maschio-femmina girevole JIC 37°

TUBO PIPE		ROSCA THREAD	REF. PART N°	€
6	1/4	7/16" 20h UNF	S68006	4,55
8	5/16	1/2" 20h UNF	S68008	4,33
10	3/8	9/16" 18h UNF	S68010	4,33
12	1/2	3/4" 16h UNF	S68012	6,93
14-15-16	5/8	7/8" 14h UNF	S68016	8,60
18-20	3/4	1"1/16 12h UNF	S68020	10,76
25	1	1"5/16 12h UNF	S68025	20,80
30-32	1 1/4	1"5/8 12h UNF	S68032	72,35
38	1 1/2	1"7/8 12h UNF	S68038	108,05

Te macho JIC 37° - macho orientable BSP central

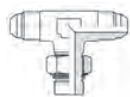

Té orientable mâle JIC 37° x mâle gaz cyl + or BAE x mâle JIC 37° équipé

Tee male JIC 37°-BSP central Banjo male-male JIC 37°

Raccordo a T JIC 37° orientabile centrale BSP (maschio-maschio orientabile-maschio)

TUBO PIPE		ROSCA THREAD		REF. PART N°	€
6	1/4	7/16" 20h UNF	1/4" BSP	S6100613	4,26
8	5/16	1/2" 20h UNF	1/4" BSP	S6100813	11,97
10	3/8	9/16" 18h UNF	1/4" BSP	S6101013	4,26
10	3/8	9/16" 18h UNF	3/8" BSP	S6101017	24,03
12	1/2	3/4" 16h UNF	3/8" BSP	S6101217	5,42
14-15-16	5/8	7/8" 14h UNF	1/2" BSP	S6101621	9,39
18-20	3/4	1"1/16 12h UNF	3/4" BSP	S6102026	29,18
25	1	1"5/16 12h UNF	1" BSP	S6102533	20,08
30-32	1 1/4	1"5/8 12h UNF	1"1/4 BSP	S6103242	74,73

Te macho JIC 37° - macho orientable UNF central



Té orientable mâle JIC 37° x mâle UNF + or BAE x mâle JIC 37° équipé

Tee male JIC 37°-central Banjo UNF-male JIC 37°

Raccordo a T JIC 37° orientabile centrale UNF (maschio-maschio orientabile-maschio)

TUBO PIPE		ROSCA THREAD	REFERENCIA PART N°	€
6	1/4	7/16" 20h UNF	S5850611	12,02
8	5/16	1/2" 20h UNF	S5850812	16,08
10	3/8	9/16" 18h UNF	S5851014	16,42
12	1/2	3/4" 16h UNF	S5851219	16,18
14-15-16	5/8	7/8" 14h UNF	S5851622	24,42
18-20	3/4	1"1/16 12h UNF	S5852027	32,23
25	1	1"5/16 12h UNF	S5852533	48,30

Racores JIC 37°

Raccords JIC 37°
JIC 37° fittings
Raccordi JIC 37°

Pipe

DIN 2353 Pipe Fittings

Gas tube fittings

JIC 37° fittings

SAE Flanges

Clamps

Machines for
processing rigid pipes

Te macho JIC 37° - macho orientable métrico central

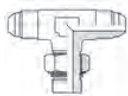

Té orientable mâle JIC 37° x mâle Métrique + or BAE x mâle JIC 37° équipé

Tee male JIC 37°-Metric central Banjo male-male JIC 37°

Raccordo a T JIC 37° orientabile centrale Metrico (maschio-maschio orientabile-maschio)

TUBO PIPE		ROSCA THREAD		REFERENCIA PART N°	€
6	1/4	7/16" JIC	M10X1	S6350610	11,89
8	5/16	1/2" JIC	M12X1.5	S6350812	14,75
10	3/8	9/16" JIC	M14X1.5	S6351014	12,74
12	1/2	3/4" JIC	M18x1.5	S6351218	17,37
14-15-16	5/8	7/8" JIC	M18x1.5	S6351618	27,07
14-15-16	5/8	7/8" JIC	M22X1.5	S6351622	27,07
18-20	3/4	1"1/16 JIC	M27X2	S6352027	33,95
25	1	1"5/16 JIC	M33X2	S6352533	44,36

Te macho JIC 37° - macho orientable BSP lateral



Té orientable mâle JIC 37° x mâle JIC 37° x mâle gaz cyl + or BAE équipé

Tee male JIC 37°-BSP lateral Banjo male-male JIC 37°

Raccordo a T JIC 37° orientabile laterale BSP (maschio-maschio-maschio orientabile)

TUBO PIPE		ROSCA THREAD		REF. PART N°	€
8	5/16	1/2" 20h UNF	1/4" BSP	S6050813	3,90
10	3/8	9/16" 18h UNF	1/4" BSP	S6051013	11,68
12	1/2	3/4" 16h UNF	3/8" BSP	S6051217	5,35
14-15-16	5/8	7/8" 14h UNF	1/2" BSP	S6051621	7,66
18-20	3/4	1"1/16 12h UNF	3/4" BSP	S6052026	15,75
25	1	1"5/16 12h UNF	1" BSP	S6052533	43,91
30-32	1 1/4	1"5/8 12h UNF	1"1/4 BSP	S6053242	66,10
38	1 1/2	1"7/8 12h UNF	1"1/2 BSP	S6053848	90,65

Te macho JIC 37° - macho orientable UNF lateral

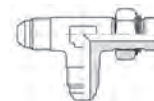

Té orientable mâle JIC 37° x mâle JIC 37°x mâle UNF + or BAE équipé

Tee male JIC 37°-lateral Banjo UNF-male JIC 37°

Raccordo a T JIC 37° orientabile laterale UNF (maschio-maschio-maschio orientabile)

TUBO PIPE		ROSCA THREAD		REFERENCIA PART N°	€
6	1/4	7/16" JIC	7/16" UNF	S5800611	19,01
8	5/16	1/2" JIC	1/2" UNF	S5800812	19,01
10	3/8	9/16" JIC	9/16" UNF	S5801014	11,63
16	5/8	7/8" JIC	7/8" UNF	S5801622	22,91
20	3/4	1"1/16 JIC	1"1/16 UNF	S5802027	35,41
25	1	1"5/16 JIC	1"5/16 UNF	S5802533	52,70

Te macho JIC 37° - macho orientable métrico lateral

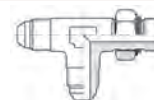

Té orientable mâle JIC 37° x mâle JIC 37°x mâle Métrique + or BAE équipé

Tee male JIC 37°-Metric lateral Banjo male-male JIC 37°

Raccordo a T JIC 37° orientabile laterale Metrico (maschio-maschio-maschio orientabile)

TUBO PIPE		ROSCA THREAD		REFERENCIA PART N°	€
10	3/8	9/16" 18h UNF	M14x1,5	S6301014	12,74
12	1/2	3/4" 16h UNF	M16x1,5	S6301216	16,58
12	1/2	3/4" 16h UNF	M18x1,5	S6301218	21,32
14-15-16	5/8	7/8" 14h UNF	M18x1,5	S6301618	26,54
14-15-16	5/8	7/8" 14h UNF	M22x1,5	S6301622	26,54
18-20	3/4	1"1/16 12h UNF	M27X1.5	S6302027	33,95
25	1	1"5/16 12h UNF	M33x2	S6302533	53,71

Artículos bajo consulta

Articles à consulter | Items on request | Articoli su richiesta

S160

Racor macho NPT - hembra giratoria JIC 37° | Adaptateur tournante JIC 37° x NPT équipé | Adaptor swivel nut JIC-male NPT | Niples maschio-femmina NPT-JIC 37°

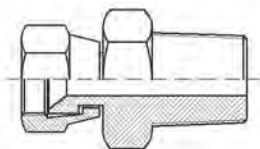

S170

Racor macho UNF - hembra giratoria JIC 37° | Adaptateur tournante JIC 37° x UNF équipé | Adaptor swivel nut JIC-male UNF | Niples maschio-femmina UNF-JIC 37°

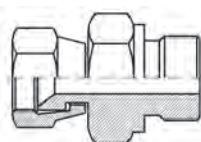

S190

Racor macho Métrico - hembra giratoria JIC 37° | Adaptateur tournante JIC 37° x Métrique équipé | Adaptor swivel nut JIC-male UNF | Niples maschio-femmina UNF-JIC 37°

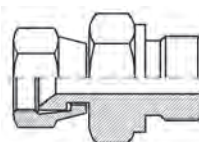

S530

Te macho JIC 37° - macho NPT lateral | Té mâle JIC 37° x mâle JIC 37° x mâle NPT équipé | Tee male JIC 37°-male JIC 37°-lateral NPT male | Raccordo a T maschio JIC 37°-maschio JIC 37°-maschio laterale (NPT)

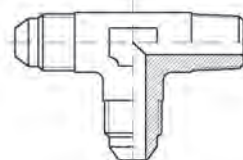

S535

Te macho JIC 37° - macho NPT central | Té mâle JIC 37° x mâle JIC 37° x mâle JIC 37° équipé | Tee male JIC 37°-NPT central male-male JIC 37° | Raccordo a T maschio JIC 37° - maschio centrale NPT-maschio JIC 37°

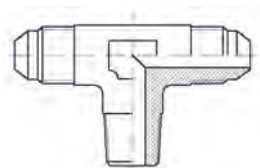

S540

Codo 45° macho JIC 37° - macho NPT | Adaptateur coude 45° mâle JIC 37° x mâle NPT équipé | 45° Elbow male JIC 37°-male NPT | Adattatore a 45° maschio JIC 37°-maschio NPT

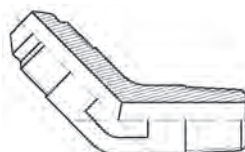

S555

Te macho JIC 37° - macho BSPT lateral | Té mâle JIC 37° x mâle JIC 37° x mâle BSPT équipé | Tee male JIC 37°-male JIC 37°-lateral BSPT male | Raccordo a T maschio JIC 37°-maschio JIC 37°-maschio laterale BSPT

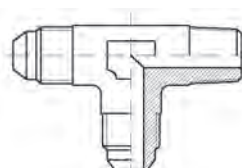

S560

Te macho JIC 37° - macho BSPT central | Té mâle JIC 37° x mâle BSPT x mâle JIC 37° équipé | Tee male JIC 37°-BSPT central male-male JIC 37° | Raccordo a T maschio JIC 37° - maschio centrale BSPT-maschio JIC 37°

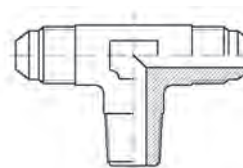

S565

Codo 45° macho JIC 37° - macho BSPT | Adaptateur coude 45° mâle JIC 37° x mâle BSPT équipé | 45° Elbow male JIC 37°-male BSPT | Adattatore a 45° maschio JIC 37°-maschio BSPT

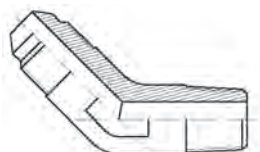

S590

Codo 45° macho JIC 37° - macho UNF orient. | Adaptateur coude 45° mâle JIC 37° x mâle UNF + o'ring et bae équipé | 45° Elbow male JIC 37°-UNF Banjo male | Adattatore a 45° maschio JIC 37°-maschio UNF orientabile

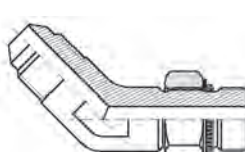

S655

Te macho JIC 37° pasatabiques lateral | Té mâle JIC 37° x mâle JIC 37° x passe cloison mâle JIC 37° équipé | Tee male JIC 37°- male JIC 37°- lateral bulkhead male JIC 37° | Raccordo a T maschio JIC 37°-maschio JIC 37°-passaparete laterale maschio JIC 37°

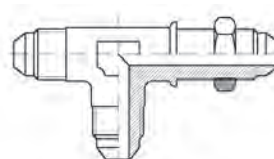

S660

Te macho JIC 37° pasatabiques central | Té mâle JIC 37° x passe cloison mâle JIC 37° x mâle JIC 37° équipé | Tee male JIC 37°- central bulkhead male JIC 37°- male JIC 37° | Raccordo a T maschio JIC 37°-passaparete centrale maschio JIC 37°-maschio JIC 37°

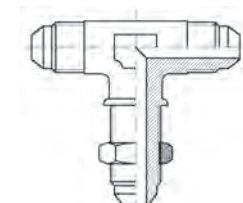

S665

Codo 45° pasatabiques macho - macho JIC 37° | Coude 45° passe cloison mâle-mâle JIC 37° | 45° Bulkhead elbow male - male JIC 37° | Adattatore a 45° passaparete maschio - maschio JIC 37°

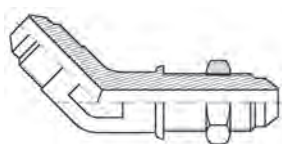

Bridas SAE

Brides de fixation SAE
SAE Flanges
Flange SAE

Bridas SAE

Brides de fixation SAE | SAE Flanges | Flange SAE

Pipe

▶ **Bridas Roscadas** | Brides taraudées | Threaded flanges | Flange filettate

169



AFS...G



GFS...G



AFS...90G

DIN 2353 Pipe Fittings

▶ **Bridas soldables tubo gas** | Brides à souder pour tube gaz | Welding flanges for gas tube | Flange a saldare per tubo gas

170

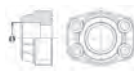

AFS...S



GFS...S



AFS...90S

Gas tube fittings

▶ **Bridas soldables tubo métrico** | Brides à souder pour tube métrique | Welding flanges for metric tube | Flange a saldare per tubo Metrico

171



AFS...SA



GFS...SA



AFS...90SA

JIC 37° fittings

▶ **Bridas soldables macho** | Brides à souder mâle | Male welding flanges | Flangia a saldare maschio

172



AFS...ST



GFS...ST



AFS...RE



GFS...RE



AFS...STRE



GFS...STRE

SAE Flanges

▶ **Bridas roscadas macho** | Brides taraudées mâle | Male threaded flanges | Flange filettate maschio

174



AFS...B



AFS...E

▶ **Bridas ciegas** | Brides avec obturateur fermé | Blind flanges | Flange cieche

174

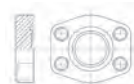

AFC



GFC

Clamps

▶ **Bridas para flexibles** | Brides SAE pour flexibles | SAE Flanges for hoses | Flange SAE per tubi flessibili

175

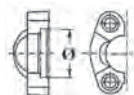

AFS...

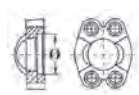

AFSI...

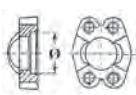

GFSI...

Machines for processing rigid pipes

► **Conos soldar** | Collets à souder | Welding adaptors for flanges | Ogive a saldare

176



SFS...ST

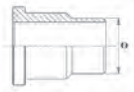

SFS...STC

► **Bridas Cetop** | Brides Cetop | Cetop flanges | Flange Cetop

176

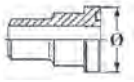

COD...ST

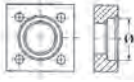

CET...ST

Bridas SAE

Brides de fixation SAE
SAE Flanges
Flange SAE

Brida roscada hembra BSP

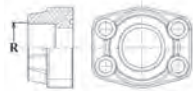

Bride taraudée femelle BSP
BSP Female threaded flange
Flangia filettata femmina BSP

SERIE	ROSCA THREAD	TAMAÑO SIZE	REFERENCIA PART N°	€
3000 PSI	1/2" BSP	1/2"	AFS080G	18,41
3000 PSI	3/8" BSP	1/2"	AFS080G038	18,41
3000 PSI	3/4" BSP	3/4"	AFS100G	19,19
3000 PSI	1/2" BSP	3/4"	AFS100G012	19,19
3000 PSI	1" BSP	1"	AFS102G	23,27
3000 PSI	3/4" BSP	1"	AFS102G034	23,27
3000 PSI	1"1/4 BSP	1"1/4"	AFS104G	28,29
3000 PSI	1" BSP	1"1/4"	AFS104G100	27,71
3000 PSI	1"1/2 BSP	1"1/2"	AFS106G	35,22
3000 PSI	1"1/4 BSP	1"1/2"	AFS106G114	35,22
3000 PSI	2" BSP	2"	AFS108G	43,29
3000 PSI	1"1/2 BSP	2"	AFS108G112	43,29
3000 PSI	2"1/2 BSP	2"1/2"	AFS110G	53,01
3000 PSI	2" BSP	2"1/2"	AFS110G200	53,01
3000 PSI	3" BSP	3"	AFS112G	65,38
3000 PSI	2"1/2 BSP	3"	AFS112G212	71,48
3000 PSI	3"1/2 BSP	3"1/2"	AFS114G	93,15
3000 PSI	3" BSP	3"1/2"	AFS114G300	101,72
3000 PSI	4" BSP	4"	AFS116G	100,88
3000 PSI	3"1/2 BSP	4"	AFS116G312	110,25
6000 PSI	1/2" BSP	1/2"	AFS401G012	19,99
6000 PSI	3/8" BSP	1/2"	AFS401G038	19,99
6000 PSI	3/4" BSP	3/4"	AFS402G	23,74
6000 PSI	1/2" BSP	3/4"	AFS402G012	23,74
6000 PSI	1" BSP	1"	AFS403G	28,44
6000 PSI	3/4" BSP	1"	AFS403G034	28,44
6000 PSI	1"1/4 BSP	1"1/4"	AFS404G	36,13
6000 PSI	1" BSP	1"1/4"	AFS404G100	36,13
6000 PSI	1"1/2 BSP	1"1/2"	AFS405G	54,27
6000 PSI	1"1/4 BSP	1"1/2"	AFS405G114	54,27
6000 PSI	2" BSP	2"	AFS406G	78,68
6000 PSI	1"1/2 BSP	2"	AFS406G112	78,68

Contrabrida roscada hembra BSP

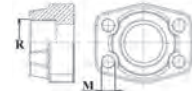

Contre-bride taraudée femelle BSP
BSP Female threaded counter-flange
Controflangia filettata femmina BSP

SERIE	ROSCA THREAD	TAMAÑO SIZE	REFERENCIA PART N°	€
3000 PSI	1/2" BSP	1/2"	GFS080G	19,09
3000 PSI	3/8" BSP	1/2"	GFS080G038	21,32
3000 PSI	3/4" BSP	3/4"	GFS100G	20,73
3000 PSI	1/2" BSP	3/4"	GFS100G012	25,76
3000 PSI	1" BSP	1"	GFS102G	24,14
3000 PSI	3/4" BSP	1"	GFS102G034	29,33
3000 PSI	1"1/4 BSP	1"1/4"	GFS104G	29,34
3000 PSI	1" BSP	1"1/4"	GFS104G100	34,65
3000 PSI	1"1/2 BSP	1"1/2"	GFS106G	36,49
3000 PSI	1"1/4 BSP	1"1/2"	GFS106G114	42,64
3000 PSI	2" BSP	2"	GFS108G	44,97
3000 PSI	1"1/2 BSP	2"	GFS108G112	49,68
3000 PSI	2"1/2 BSP	2"1/2"	GFS110G	54,06
3000 PSI	2" BSP	2"1/2"	GFS110G200	59,28
3000 PSI	3" BSP	3"	GFS112G	65,38
3000 PSI	2"1/2 BSP	3"	GFS112G212	71,48
3000 PSI	3"1/2 BSP	3"1/2"	GFS114G	93,15
3000 PSI	3" BSP	3"1/2"	GFS114G300	101,72
3000 PSI	4" BSP	4"	GFS116G	100,88
3000 PSI	3"1/2 BSP	4"	GFS116G312	110,25
6000 PSI	1/2" BSP	1/2"	GFS401G012	19,22
6000 PSI	3/8" BSP	1/2"	GFS401G038	24,01
6000 PSI	3/4" BSP	3/4"	GFS402G	26,67
6000 PSI	1/2" BSP	3/4"	GFS402G012	29,33
6000 PSI	1" BSP	1"	GFS403G	30,20
6000 PSI	3/4" BSP	1"	GFS403G034	35,53
6000 PSI	1"1/4 BSP	1"1/4"	GFS404G	41,87
6000 PSI	1" BSP	1"1/4"	GFS404G100	49,68
6000 PSI	1"1/2 BSP	1"1/2"	GFS405G	60,83
6000 PSI	1"1/4 BSP	1"1/2"	GFS405G114	71,48
6000 PSI	2" BSP	2"	GFS406G	84,62
6000 PSI	1"1/2 BSP	2"	GFS406G112	94,03

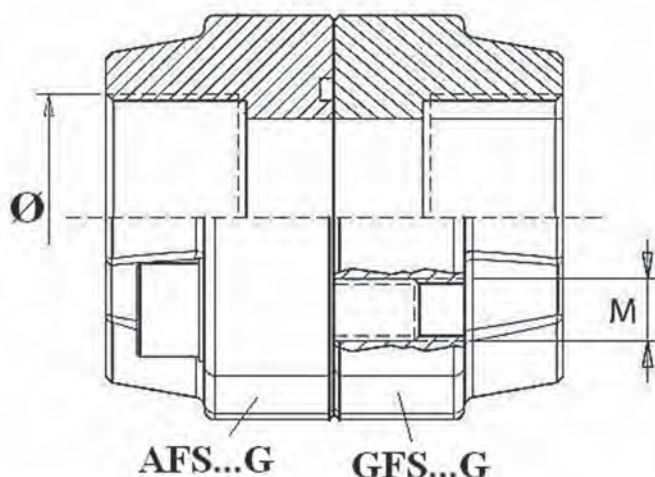

Brida codo 90° roscada hembra BSP

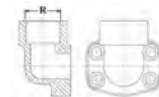

Bride 90° taraudée femelle BSP
90° BSP female threaded flange
Flangia a 90° filettata femmina BSP

SERIE	ROSCA THREAD	TAMAÑO SIZE	REFERENCIA PART N°	€
3000 PSI	1/2" BSP	1/2"	AFS08090G	35,95
3000 PSI	3/8" BSP	1/2"	AFS08090G038	47,96
3000 PSI	3/4" BSP	3/4"	AFS10090G	41,33
3000 PSI	1" BSP	1"	AFS10290G	49,61
3000 PSI	1"1/4 BSP	1"1/4"	AFS10490G	57,88
3000 PSI	1"1/2 BSP	1"1/2"	AFS10690G	78,29
3000 PSI	2" BSP	2"	AFS10890G	100,23
6000 PSI	1/2" BSP	1/2"	AFS40190G012	45,57
6000 PSI	3/8" BSP	1/2"	AFS40190G038	52,66
6000 PSI	3/4" BSP	3/4"	AFS40290G	49,89
6000 PSI	1" BSP	1"	AFS40390G	57,33
6000 PSI	1"1/4 BSP	1"1/4"	AFS40490G	81,29
6000 PSI	1"1/2 BSP	1"1/2"	AFS40590G	99,25

Bridas SAE

Brides de fixation SAE
SAE Flanges
Flange SAE

Pipe

DIN 2353 Pipe Fittings

Gas tube fittings

JIC 37° fittings

SAE Flanges

Clamps

Machines for
processing rigid pipes

Brida soldable hembra tubo gas

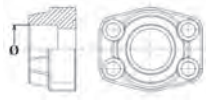

Bride à souder femelle tube gaz
Welding female flange for gas tube
Flangia femmina a saldare per tubo gas

SERIE	Ø int	TAMAÑO SIZE	REFERENCIA PART N°	€
3000 PSI	21.6	1/2"	AFS080S	16,65
3000 PSI	17.5	1/2"	AFS080S038	20,44
3000 PSI	27.2	3/4"	AFS100S	20,30
3000 PSI	34	1"	AFS102S	21,45
3000 PSI	42.8	1"1/4	AFS104S	25,56
3000 PSI	48.6	1"1/2	AFS106S	32,78
3000 PSI	61	2"	AFS108S	40,16
3000 PSI	76.6	2"1/2	AFS110S	48,99
3000 PSI	90.5	3"	AFS112S	61,88
3000 PSI	103	3"1/2	AFS114S	88,03
3000 PSI	115.5	4"	AFS116S	94,03
6000 PSI	21.6	1/2"	AFS401S012	20,40
6000 PSI	17.5	1/2"	AFS401S038	23,10
6000 PSI	27.2	3/4"	AFS402S	24,05
6000 PSI	34	1"	AFS403S	28,85
6000 PSI	42.8	1"1/4	AFS404S	37,05
6000 PSI	48.6	1"1/2	AFS405S	55,58
6000 PSI	61	2"	AFS406S	80,34

Contrabrida soldable hembra tubo gas

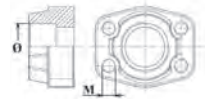

Contre-bride à souder femelle tube gaz
Welding female counter-flange for gas tube
Controflangia femmina a saldare per tubo gas

SERIE	Ø int	TAMAÑO SIZE	REFERENCIA PART N°	€
3000 PSI	21.6	1/2"	GFS080S	16,67
3000 PSI	17.5	1/2"	GFS080S038	20,44
3000 PSI	27.2	3/4"	GFS100S	20,35
3000 PSI	34	1"	GFS102S	21,45
3000 PSI	42.8	1"1/4	GFS104S	25,53
3000 PSI	48.6	1"1/2	GFS106S	32,77
3000 PSI	61	2"	GFS108S	40,10
3000 PSI	76.6	2"1/2	GFS110S	48,85
3000 PSI	90.5	3"	GFS112S	61,88
3000 PSI	103	3"1/2	GFS114S	88,03
3000 PSI	115.5	4"	GFS116S	94,03
6000 PSI	21.6	1/2"	GFS401S012	20,38
6000 PSI	27.2	3/4"	GFS402S	24,00
6000 PSI	34	1"	GFS403S	28,81
6000 PSI	42.8	1"1/4	GFS404S	37,17
6000 PSI	48.6	1"1/2	GFS405S	55,64
6000 PSI	61	2"	GFS406S	80,34

Brida codo 90° soldable hembra tubo gas

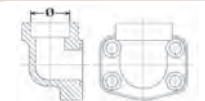

Bride 90° à souder femelle tube gaz
90° welding female flange for gas tube
Flangia a 90° femmina a saldare per tubo gas

SERIE	Ø int	TAMAÑO SIZE	REFERENCIA PART N°	€
3000 PSI	21.6	1/2"	AFS08090S	39,73
3000 PSI	17.5	1/2"	AFS08090S038	44,45
3000 PSI	27.2	3/4"	AFS10090S	43,05
3000 PSI	34	1"	AFS10290S	50,65
3000 PSI	42.8	1"1/4	AFS10490S	60,31
3000 PSI	48.6	1"1/2	AFS10690S	66,86
3000 PSI	61	2"	AFS10890S	90,22
6000 PSI	21.6	1/2"	AFS40190S012	44,35
6000 PSI	17.5	1/2"	AFS40190S038	47,96
6000 PSI	27.2	3/4"	AFS40290S	50,65
6000 PSI	34	1"	AFS40390S	54,24
6000 PSI	42.8	1"1/4	AFS40490S	75,83
6000 PSI	48.6	1"1/2	AFS40590S	90,11

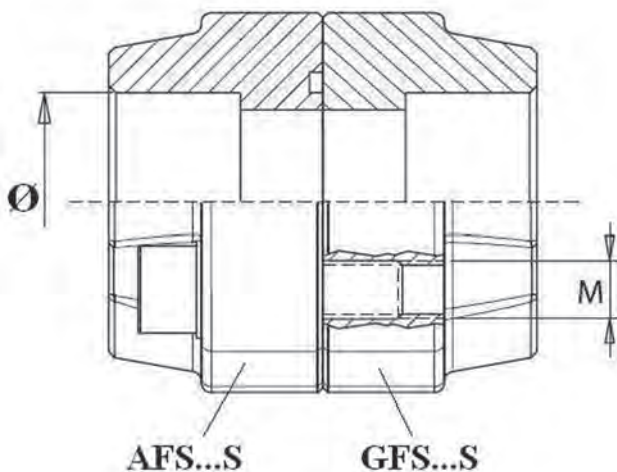

Bridas SAE

Brides de fixation SAE
SAE Flanges
Flange SAE

Brida soldable hembra tubo métrico

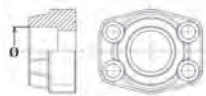

Bride à souder femelle tube métrique
Female welding flange for metric tube
Flangia femmina a saldare per tubo Metrico

SERIE	Ø int	TAMAÑO SIZE	REFERENCIA PART N°	€
3000 PSI	20.3	1/2"	AFS080SA20	20,44
3000 PSI	25.3	3/4"	AFS100SA25	21,32
3000 PSI	30.3	1"	AFS102SA30	24,89
3000 PSI	38.3	1"1/4	AFS104SA38	28,42
3000 PSI	50.5	1"1/2	AFS106SA50	36,44
6000 PSI	20.3	1/2"	AFS401SA20	23,10
6000 PSI	25.3	3/4"	AFS402SA25	24,89
6000 PSI	30.3	1"	AFS403SA30	29,33
6000 PSI	38.3	1"1/4	AFS404SA38	40,98
6000 PSI	50.5	1"1/2	AFS405SA50	61,00

Brida codo 90° soldable hembra tubo métrico

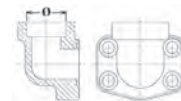

Bride 90° à souder femelle tube métrique
90° female welding flange for metric tube
Flangia a 90° femmina a saldare per tubo Metrico

SERIE	Ø int	TAMAÑO SIZE	REFERENCIA PART N°	€
3000 PSI	20.3	1/2"	AFS08090SA20	44,45
3000 PSI	25.3	3/4"	AFS10090SA25	47,96
3000 PSI	30.3	1"	AFS10290SA30	53,18
3000 PSI	38.3	1"1/4	AFS10490SA38	61,88
3000 PSI	50.5	1"1/2	AFS10690SA50	75,83
6000 PSI	20.3	1/2"	AFS40190SA20	47,96
6000 PSI	25.3	3/4"	AFS40290SA25	53,18
6000 PSI	30.3	1"	AFS40390SA30	61,88
6000 PSI	38.3	1"1/4	AFS40490SA38	75,83
6000 PSI	50.3	1"1/2	AFS40590SA50	92,38

Contrabrida soldable hembra tubo métrico

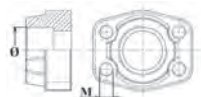

Contre-bride à souder femelle tube métrique
Female welding counter-flange for metric tube
Controflangia femmina a saldare per tubo Metrico

SERIE	Ø int	TAMAÑO SIZE	REFERENCIA PART N°	€
3000 PSI	20.3	1/2"	GFS080SA20	20,44
3000 PSI	25.3	3/4"	GFS100SA25	21,32
3000 PSI	30.3	1"	GFS102SA30	24,89
3000 PSI	38.3	1"1/4	GFS104SA38	28,42
6000 PSI	20.3	1/2"	GFS401SA20	23,10
6000 PSI	25.3	3/4"	GFS402SA25	24,85
6000 PSI	30.3	1"	GFS403SA30	29,33
6000 PSI	38.3	1"1/4	GFS404SA38	40,98
6000 PSI	50.5	1"1/2	GFS405SA50	61,00

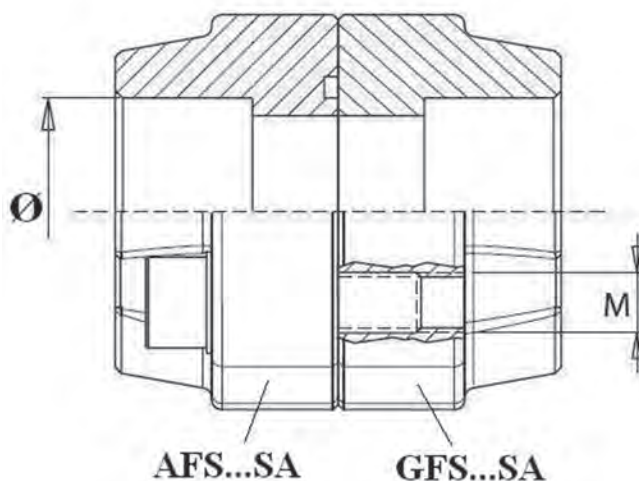

Bridas SAE

Brides de fixation SAE
SAE Flanges
Flange SAE

Pipe

DIN 2353 Pipe Fittings

Gas tube fittings

JIC 37° fittings

SAE Flanges

Clamps

Machines for processing rigid pipes

Brida soldable macho tubo gas

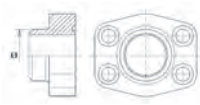

Bride à souder mâle tube gaz
Male welding flange for gas tube
Flangia a saldare maschio tubo gas

SERIE	Ø ext	TAMAÑO SIZE	REFERENCIA PART N°	€
3000 PSI	21.5	1/2"	AFS080ST	20,44
3000 PSI	17.5	1/2"	AFS080ST038	20,44
3000 PSI	28	3/4"	AFS100ST	21,32
3000 PSI	34	1"	AFS102ST	24,89
3000 PSI	42.8	1"1/4	AFS104ST	28,42
3000 PSI	48.6	1"1/2	AFS106ST	36,44
3000 PSI	61	2"	AFS108ST	43,58
3000 PSI	77	2"1/2	AFS110ST	51,43
3000 PSI	92	3"	AFS112ST	61,88
3000 PSI	103	3"1/2	AFS114ST	88,03
6000 PSI	21.5	1/2"	AFS401ST012	23,10
6000 PSI	17.5	1/2"	AFS401ST038	23,10
6000 PSI	28	3/4"	AFS402ST	24,89
6000 PSI	34	1"	AFS403ST	29,33
6000 PSI	42.8	1"1/4	AFS404ST	40,98
6000 PSI	48.6	1"1/2	AFS405ST	61,00
6000 PSI	61	2"	AFS406ST	80,34

Brida soldable macho tubo métrico

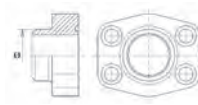

Bride à souder mâle tube métrique
Male welding flange for metric tube
Flangia a saldare maschio tubo Metrico

SERIE	Ø ext	TAMAÑO SIZE	REFERENCIA PART N°	€
3000 PSI	25	3/4"	AFS100SRE25	21,32
3000 PSI	30	1"	AFS102SRE30	24,89
3000 PSI	38	1"1/4	AFS104SRE38	28,42
3000 PSI	42	1"1/2	AFS106SRE42	36,44
3000 PSI	61	2"	AFS108SRE60	43,58
3000 PSI	49	2"	AFS108STRE48	43,58
3000 PSI	77	3"	AFS112SRE76	61,88
3000 PSI	77	3"	AFS112STRE76	61,88
3000 PSI	77	3"1/2	AFS114STRE76	88,03
3000 PSI	90	3"1/2	AFS114STRE88	88,03
3000 PSI	77	4"	AFS116STRE76	94,03
3000 PSI	90	4"	AFS116STRE88	94,03
6000 PSI	20	1/2"	AFS401SRE20	23,10
6000 PSI	20	3/4"	AFS402SRE20	24,89
6000 PSI	25	3/4"	AFS402SRE25	24,89
6000 PSI	25	1"	AFS403SRE25	29,33
6000 PSI	30	1"	AFS403SRE30	29,33
6000 PSI	38	1"1/4	AFS404SRE38	40,98
6000 PSI	38	1"1/2	AFS405SRE38	61,00
6000 PSI	61	2"	AFS406SRE60	80,34

Contrabrida soldable macho tubo gas

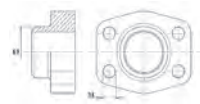

Contre-bride à souder mâle tube gaz
Male welding counter-flange for gas tube
Controflangia a saldare maschio tubo gas

SERIE	Ø ext	TAMAÑO SIZE	REFERENCIA PART N°	€
3000 PSI	21.5	1/2"	GFS080ST	20,44
3000 PSI	17.5	1/2"	GFS080ST038	20,44
3000 PSI	28	3/4"	GFS100ST	21,32
3000 PSI	34	1"	GFS102ST	24,89
3000 PSI	42.8	1"1/4	GFS104ST	28,42
3000 PSI	48.6	1"1/2	GFS106ST	36,44
3000 PSI	61	2"	GFS108ST	43,58
3000 PSI	77	2"1/2	GFS110ST	51,40
3000 PSI	92	3"	GFS112ST	61,88
3000 PSI	103	3"1/2	GFS114ST	88,03
3000 PSI	115.5	4"	GFS116ST	94,03
6000 PSI	21.5	1/2"	GFS401ST012	23,10
6000 PSI	17.5	1/2"	GFS401ST038	23,10
6000 PSI	28	3/4"	GFS402ST	24,89
6000 PSI	34	1"	GFS403ST	29,33
6000 PSI	42.8	1"1/4	GFS404ST	40,98
6000 PSI	48.6	1"1/2	GFS405ST	61,00
6000 PSI	61	2"	GFS406ST	80,34

Contrabrida soldable macho tubo métrico

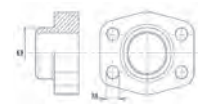

Contre-bride à souder mâle tube métrique
Male welding counter-flange for metric tube
Controflangia a saldare maschio tubo Metrico

SERIE	Ø ext	TAMAÑO SIZE	REFERENCIA PART N°	€
3000 PSI	25	3/4"	GFS100SRE25	21,32
3000 PSI	30	1"	GFS102SRE30	24,89
3000 PSI	38	1"1/4	GFS104SRE38	28,42
3000 PSI	42	1"1/2	GFS106SRE42	36,44
3000 PSI	49	1"1/2	GFS106SRE48	36,44
3000 PSI	61	2"	GFS108SRE60	43,58
3000 PSI	49	2"	GFS108STRE48	43,58
3000 PSI	77	2"1/2	GFS110SRE76	51,43
3000 PSI	77	3"	GFS112SRE76	61,88
3000 PSI	77	3"	GFS112STRE76	61,88
3000 PSI	77	3"1/2	GFS114STRE76	88,03
3000 PSI	90	3"1/2	GFS114STRE88	88,03
3000 PSI	90	4"	GFS116STRE88	94,03
6000 PSI	20	1/2"	GFS401SRE20	23,10
6000 PSI	20	3/4"	GFS402SRE20	24,89
6000 PSI	25	3/4"	GFS402SRE25	24,89
6000 PSI	25	1"	GFS403SRE25	29,33
6000 PSI	30	1"	GFS403SRE30	29,33
6000 PSI	38	1"1/4	GFS404SRE38	40,98
6000 PSI	38	1"1/2	GFS405SRE38	61,00
6000 PSI	61	2"	GFS406SRE60	80,34

Bridas SAE

Brides de fixation SAE
SAE Flanges
Flange SAE

Brida soldable macho serie L tubo métrico

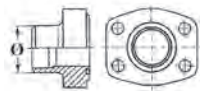

Bride à souder mâle série L tube métrique
Male welding flange L serie for metric tube
Flangia a saldare maschio serie L tubo Metrico

SERIE	Ø ext	TAMAÑO SIZE	REFERENCIA PART N°	€
3000 PSI	20	1/2"	AFS080SRE20	20,44
3000 PSI	22	1/2"	AFS080SRE22	20,44
3000 PSI	28	3/4"	AFS100SRE28	21,32
3000 PSI	35	1"	AFS102SRE35	24,89
3000 PSI	43	1"1/4	AFS104SRE42	28,42
3000 PSI	49	1"1/2	AFS106STRE48	36,44
3000 PSI	61	2"	AFS108STRE60	43,58
3000 PSI	77	2" 1/2	AFS110STRE76	51,43
3000 PSI	90	3"	AFS112STRE88	61,88
3000 PSI	115	4"	AFS116STRE114	94,03

Contrabrida soldable macho serie L tubo métrico

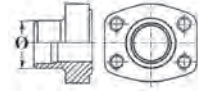

Contre-bride à souder mâle série L tube métrique
Male welding counter-flange L serie for metric tube
Controflangia a saldare maschio seriel L tubo Metrico

SERIE	Ø ext	TAMAÑO SIZE	REFERENCIA PART N°	€
3000 PSI	20	1/2"	GFS080SRE20	20,44
3000 PSI	22	1/2"	GFS080SRE22	20,44
3000 PSI	28	3/4"	GFS100SRE28	21,32
3000 PSI	35	1"	GFS102SRE35	24,89
3000 PSI	43	1"1/4	GFS104SRE42	28,42
3000 PSI	49	1"1/2	GFS106STRE48	36,44
3000 PSI	61	2"	GFS108STRE60	43,58
3000 SPI	77	2"1/2	GFS110STRE76	51,43
3000 PSI	90	3"	GFS112STRE88	61,88
3000 PSI	115	4"	GFS116STRE114	94,03

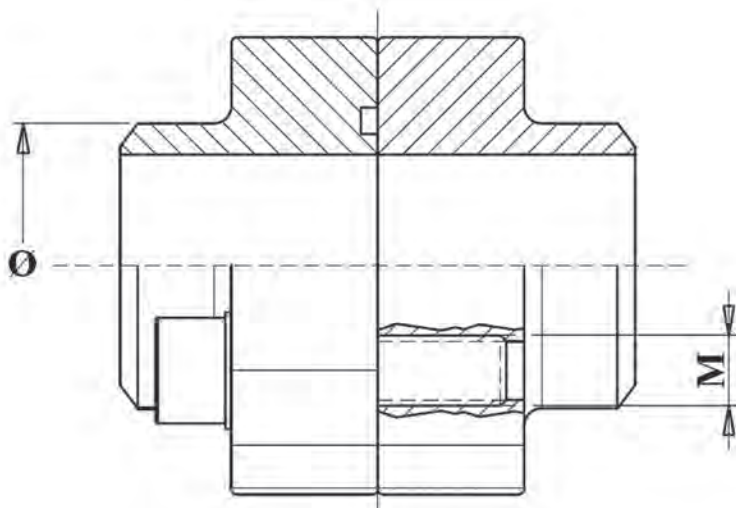

Bridas SAE

Bridas de fixation SAE
SAE Flanges
Flange SAE

Pipe

DIN 2353 Pipe Fittings

Gas tube fittings

JIC 37° fittings

SAE Flanges

Clamps

Machines for processing rigid pipes

Brida roscada macho BSP

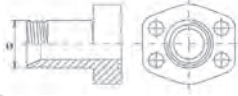

Bridas tarau­dées mâle BSP
BSP Male threaded flange
Flangia maschio filettata BSP

SERIE	ROSCA THREAD	TAMAÑO SIZE	REFERENCIA PART N°	€
3000 PSI	1/2" BSP	1/2"	AFS080B	30,21
3000 PSI	3/8" BSP	1/2"	AFS080B038	34,65
3000 PSI	3/4" BSP	3/4"	AFS100B	34,65
3000 PSI	1/2" BSP	3/4"	AFS100B012	38,22
3000 PSI	1" BSP	1"	AFS102B	40,88
3000 PSI	3/4" BSP	1"	AFS102B034	45,30
3000 PSI	1"1/4 BSP	1"1/4"	AFS104B	48,86
3000 PSI	1" BSP	1"1/4"	AFS104B100	54,19
3000 PSI	1"1/2 BSP	1"1/2"	AFS106B	58,63
3000 PSI	1"1/4 BSP	1"1/2"	AFS106B114	65,74
6000 PSI	1/2" BSP	1/2"	AFS401B	32,87
6000 PSI	3/8" BSP	1/2"	AFS401B038	35,53
6000 PSI	3/4" BSP	3/4"	AFS402B	39,97
6000 PSI	1/2" BSP	3/4"	AFS402B012	43,54
6000 PSI	1" BSP	1"	AFS403B	48,86
6000 PSI	3/4" BSP	1"	AFS403B034	53,31
6000 PSI	1"1/4 BSP	1"1/4"	AFS404B	57,53
6000 PSI	1" BSP	1"1/4"	AFS404B100	64,50
6000 PSI	1"1/2 BSP	1"1/2"	AFS405B	67,98
6000 PSI	1"1/4 BSP	1"1/2"	AFS405B114	74,95

Brida roscada macho métrico

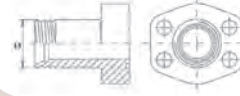

Bridas tarau­dées mâle Métrique
Metric Male threaded flange
Flangia maschio filettata Metrica

SERIE	ROSCA THREAD	TAMAÑO SIZE	REFERENCIA PART N°	€
3000 PSI	M22x1,5	1/2"	AFS080E	30,21
3000 PSI	M30x2	3/4"	AFS100E	34,65
3000 PSI	M36x2	1"	AFS102E	40,88
3000 PSI	M45x2	1"1/4"	AFS104E	48,86
3000 PSI	M52x2	1"1/2"	AFS106E	58,63
6000 PSI	M24x1.5	1/2"	AFS401E	32,87
6000 PSI	M36X2	3/4"	AFS402E	39,97
6000 PSI	M42x2	1"	AFS403E	48,86
6000 PSI	M52x2	1"1/4"	AFS404E	57,53
6000 PSI	M52x2	1"1/2"	AFS405E	67,98

Bridas ciegas

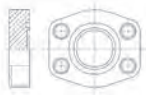

Bridas avec obturateur fermé
Blind flanges
Flange cieche

SERIE	TAMAÑO SIZE	REFERENCIA PART N°	€
3000 PSI	1/2"	AFC080	14,28
3000 PSI	3/4"	AFC100	14,30
3000 PSI	1"	AFC102	14,35
3000 PSI	1"1/4"	AFC104	17,41
3000 PSI	1"1/2"	AFC106	20,58
3000 PSI	2"	AFC108	23,56
3000 PSI	2"1/2"	AFC110	27,03
3000 PSI	3"	AFC112	39,83
3000 PSI	3"1/2"	AFC114	50,45
3000 PSI	4"	AFC116	53,86
3000 PSI	5"	AFC118	114,54
6000 PSI	1/2"	AFC401	17,30
6000 PSI	3/4"	AFC402	18,66
6000 PSI	1"	AFC403	21,32
6000 PSI	1"1/4"	AFC404	25,28
6000 PSI	1"1/2"	AFC405	29,66
6000 PSI	2"	AFC406	47,02

Contrabridas ciegas

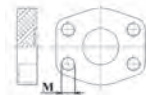

Contre-brides avec obturateur fermé
Blind counter-flanges
Controflange cieche

SERIE	TAMAÑO SIZE	REFERENCIA PART N°	€
3000 PSI	1/2"	GFC080	14,74
3000 PSI	3/4"	GFC100	16,00
3000 PSI	1"	GFC102	18,66
3000 PSI	1"1/4"	GFC104	19,57
3000 PSI	1"1/2"	GFC106	23,10
3000 PSI	2"	GFC108	23,56
3000 PSI	2"1/2"	GFC110	27,05
3000 PSI	3"	GFC112	42,70
3000 PSI	3"1/2"	GFC114	50,45
3000 PSI	4"	GFC116	53,86
3000 PSI	5"	GFC118	114,54
6000 PSI	1/2"	GFC401	17,78
6000 PSI	3/4"	GFC402	18,66
6000 PSI	1"	GFC403	21,32
6000 PSI	1"1/4"	GFC404	25,28
6000 PSI	1"1/2"	GFC405	29,66
6000 PSI	2"	GFC406	47,02

Bridas SAE

Brides de fixation SAE
SAE Flanges
Flange SAE

Brida partida pasante

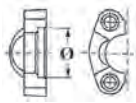

Demi-bride passage total
SAE Split flange
Semiflangia SAE

SERIE	TAMAÑO SIZE	REFERENCIA PART N°	€
3000 PSI	1/2"	AFS301	*
3000 PSI	3/4"	AFS302	*
3000 PSI	1"	AFS303	*
3000 PSI	1"1/4	AFS304	*
3000 PSI	1"1/2	AFS305	*
3000 PSI	2"	AFS306	*
3000 PSI	2"1/2	AFS307	*
3000 PSI	3"	AFS308	*
3000 PSI	3"1/2	AFS309	*
3000 PSI	4"	AFS310	*
3000 PSI	5"	AFS311	*
6000 PSI	1/2"	AFS601	*
6000 PSI	3/4"	AFS602	*
6000 PSI	1"	AFS603	*
6000 PSI	1"1/4	AFS604	*
6000 PSI	1"1/2	AFS605	*
6000 PSI	2"	AFS606	*

Ver precios en p.40 (CONEXIONES) // Prix à la p.40 (EMBOUTS) // See prices in p.40 (FITTINGS) // Vedere prezzi p.40 (RACCORDI A PRESSARE)

Brida entera pasante

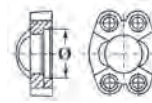

Bride monobloc passage total
SAE Flange
Flangia monoblocco SAE

SERIE	TAMAÑO SIZE	REFERENCIA PART N°	€
3000 PSI	1/2"	AFSI301	*
3000 PSI	3/4"	AFSI302	*
3000 PSI	1"	AFSI303	*
3000 PSI	1"1/4	AFSI304	*
3000 PSI	1"1/2	AFSI305	*
3000 PSI	2"	AFSI306	*
3000 PSI	2"1/2	AFSI307	*
3000 PSI	3"	AFSI308	*
3000 PSI	3"1/2	AFSI309	*
3000 PSI	4"	AFSI310	*
3000 PSI	5"	AFSI311	*
6000 PSI	1/2"	AFSI601	*
6000 PSI	3/4"	AFSI602	*
6000 PSI	1"	AFSI603	*
6000 PSI	1"1/4	AFSI604	*
6000 PSI	1"1/2	AFSI605	*
6000 PSI	2"	AFSI606	*

Ver precios en p.40 (CONEXIONES) // Prix à la p.40 (EMBOUTS) // See prices in p.40 (FITTINGS) // Vedere prezzi p.40 (RACCORDI A PRESSARE)

Contrabrida rosca Métrica

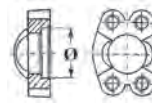

Contre-bride métrique
Metric threaded counter-flange
Controflangia filettata Metrica

SERIE	TAMAÑO SIZE	REFERENCIA PART N°	€
3000 PSI	1/2"	GFSI301	12,10
3000 PSI	3/4"	GFSI302	12,98
3000 PSI	1"	GFSI303	14,93
3000 PSI	1"1/4	GFSI304	17,59
3000 PSI	1"1/2	GFSI305	20,44
3000 PSI	2"	GFSI306	37,31
3000 PSI	2"1/2	GFSI307	48,99
3000 PSI	3"	GFSI308	70,77
3000 PSI	3"1/2	GFSI309	104,96
3000 PSI	4"	GFSI310	131,64
3000 PSI	5"	GFSI311	159,99
6000 PSI	1/2"	GFSI601	13,89
6000 PSI	3/4"	GFSI602	14,93
6000 PSI	1"	GFSI603	19,57
6000 PSI	1"1/4	GFSI604	28,26
6000 PSI	1"1/2	GFSI605	57,17
6000 PSI	2"	GFSI606	80,01

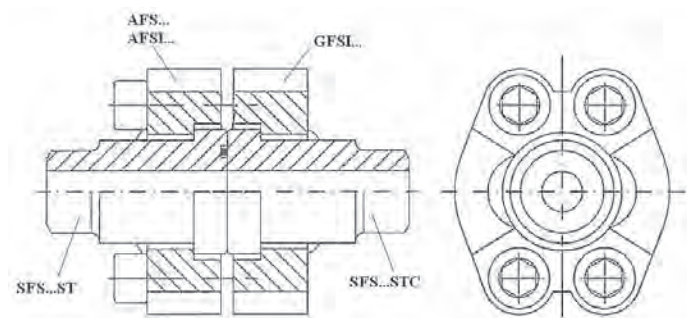

Bridas SAE

Brides de fixation SAE
SAE Flanges
Flange SAE

Pipe

DIN 2353 Pipe Fittings

Gas tube fittings

JIC 37° fittings

SAE Flanges

Clamps

Machines for processing rigid pipes

Cono soldable tubo métrico

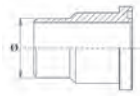

Collet à souder tube métrique
Welding adaptor for metric tube
Adattatore a saldare per tubo Metrico

SERIE	Ø ext	TAMAÑO SIZE	REFERENCIA PART N°	€
3000 PSI	16	1/2"	SFS301ST	14,83
3000 PSI	25	3/4"	SFS302ST	16,58
3000 PSI	30	1"	SFS303ST	17,46
3000 PSI	38	1"1/4	SFS304ST	22,68
3000 PSI	45	1"1/2	SFS305ST	28,78
3000 PSI	60	2"	SFS306ST	37,48
3000 PSI	70	2"1/2	SFS307ST	49,68
3000 PSI	80	3"	SFS308ST	67,10
3000 PSI	100	3"1/2	SFS309ST	114,18
3000 PSI	114.3	4"	SFS310ST	128,10
3000 PSI	139.7	5"	SFS311ST	157,72
6000 PSI	16	1/2"	SFS601ST	15,70
6000 PSI	25	3/4"	SFS602ST	16,38
6000 PSI	30	1"	SFS603ST	18,18
6000 PSI	38	1"1/4	SFS604ST	26,15
6000 PSI	45	1"1/2	SFS605ST	33,13
6000 PSI	60	2"	SFS606ST	54,90

Cono soldable tubo métrico sin junta

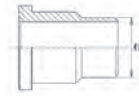

Collet à souder tube métrique sans o'ring
Welding adaptor for metric tube without o'ring
Adattatore a saldare per tubo Metrico sin o'ring

SERIE	Ø ext	TAMAÑO SIZE	REFERENCIA PART N°	€
3000 PSI	16	1/2"	SFS301STC	14,82
3000 PSI	25	3/4"	SFS302STC	16,57
3000 PSI	30	1"	SFS303STC	17,47
3000 PSI	38	1"1/4	SFS304STC	22,67
3000 PSI	45	1"1/2	SFS305STC	28,78
3000 PSI	60	2"	SFS306STC	37,47
3000 PSI	70	2"1/2	SFS307STC	28,78
3000 PSI	80	3"	SFS308STC	67,09
3000 PSI	100	3"1/2	SFS309STC	114,18
3000 PSI	114.3	4"	SFS310STC	128,10
3000 PSI	139.7	5"	SFS311STC	157,72
6000 PSI	16	1/2"	SFS601STC	15,70
6000 PSI	25	3/4"	SFS602STC	20,06
6000 PSI	30	1"	SFS603STC	22,67
6000 PSI	38	1"1/4	SFS604STC	26,16
6000 PSI	45	1"1/2	SFS605STC	33,14
6000 PSI	60	2"	SFS606STC	54,91

Cono Cetop soldable exterior

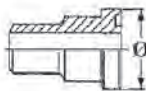

Collet Cetop à souder
Cetop welding adaptor
Adattatore a saldare Cetop

SERIE	Ø ext	TAMAÑO SIZE	REFERENCIA PART N°	€
3000 PSI	18	3/8"	COD38ST250	12,95
6000 PSI	18	3/8"	COD38ST400	15,54

Bridas Cetop

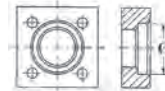

Brides Cetop
Cetop flanges
Flange Cetop

SERIE	Ø int	TAMAÑO SIZE	REFERENCIA PART N°	€
3000 PSI	31	1/2"	CET12ST250	12,95

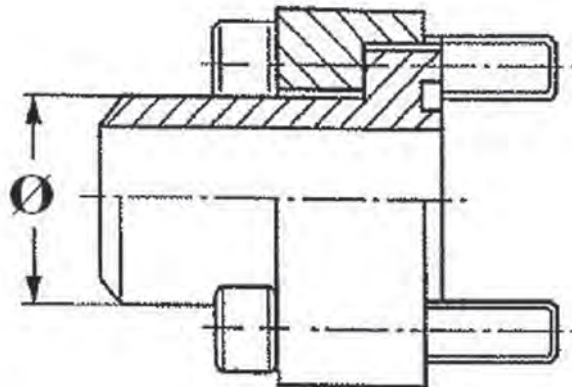
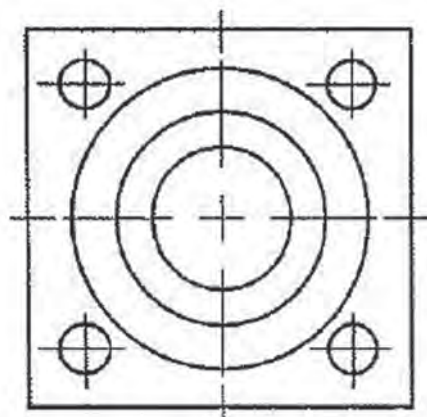

► **Características comunes** | Données communes | Common characteristics | Caratteristiche comuni

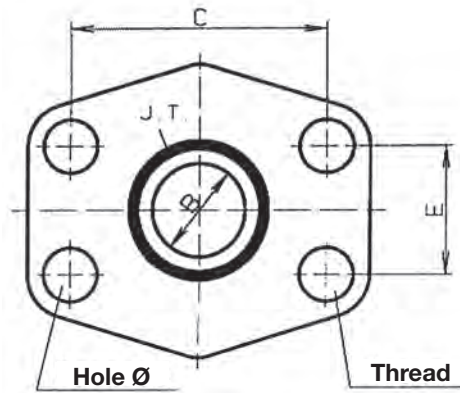

Bridas 3000 PSI | Brides 3000 PSI | Flanges 3000 PSI | Flange 3000 PSI

Tamaño Taille Size Misura	Max. pre. Max. pre. Max. pre. Max. pre.	B	C	E	O'ring O'ring O'ring O'ring	Ø	Rosca Filetage Thread Filetto
1/2"	345 bar	13	38,1	17,48	18,64x3,53	9	M8
3/4"	345 bar	19	47,63	22,23	24,99x3,53	11	M10
1	345 bar	25	52,37	26,19	32,92x3,53	11	M10
1" 1/4	276 bar	32	58,72	30,18	37,70x3,53	11,5	M10
1" 1/2	207 bar	38	69,85	35,71	47,22x3,53	13,5	M12
2	207 bar	51	77,77	42,88	56,74x3,53	13,5	M12
2 1/2"	172 bar	63	88,9	50,8	66,27x3,53	13,5	M12
3	138 bar	73	106,38	61,93	85,32x3,53	17,5	M16
3" 1/2	34 bar	89	120,65	69,85	98,02x3,53	17,5	M16
4	34 bar	99	130,18	77,77	110,72x3,53	17,5	M16

Bridas 6000 PSI | Brides 6000 PSI | Flanges 6000 PSI | Flange 6000 PSI

Tamaño Taille Size Misura	Max. pre. Max. pre. Max. pre. Max. pre.	B	C	E	O'ring O'ring O'ring O'ring	Ø	Rosca Filetage Thread Filetto
1/2"	414 bar	13	40,49	18,24	18,64x3,53	9	M8
3/4"	414 bar	19	50,8	23,8	24,99x3,53	11	M10
1	414 bar	25	57,15	27,76	32,92x3,53	13	M12
1" 1/4	414 bar	32	66,68	31,75	37,70x3,53	15	M14
1" 1/2	414 bar	38	79,38	36,5	47,22x3,53	17	M16
2	414 bar	51	96,82	44,45	56,74x3,53	21	M20
2 1/2"	414 bar	63	123,8	58,7	66,27x3,53	-	-

Abrazaderas

Colliers

Clamps

Collari fissatubo



Abrazaderas para tubo

Colliers de fixation | Clamps for pipe | Collari fissatubo

180

Abrazaderas para tubo

Colliers de fixation | Clamps for pipe | Collari fissatubo

Pipe

► Serie ligera simple | Colliers de fixation simple série légère | Light serie simple clamp | Collari fissatubo serie leggera singoli 181



A40AZ



A C



APIN



AVTC

► Serie ligera reforzada | Colliers de fixation simple série légère renforcé | Light serie reinforced clamp | Collari fissatubo serie leggera rinforzati 182



A41AZ



APS



AVTE

DIN 2353 Pipe Fittings

► Dobles / paralelas | Colliers de fixation doubles | Double clamp - parallel | Collari fissatubo doppi 183



AZCFS



ADPIN



AD C



ADPS



ADVTE

Gas tube fittings

► Serie pesada | Colliers de fixation simple série lourde | Heavy serie clamp | Collari fissatubo serie pesante 184



AMPP C



AVTEP



APINP



APSP

JIC 37° fittings

► Accesorios abrazaderas | Accessoires pour colliers | Accessories for clamps | Accessori per collari fissatubo 185



APAG



ADPAG



TC/TS



APT

SAE Flanges

► Accesorios para apilar | Accessoires empiler | Accessories for pile up | Accessori per componibili 185



AVTA



APA



ADVTA



ADPA

Clamps

Machines for processing rigid pipes

Abrazaderas para tubo

Colliers de fixation
Clamps for pipe
Collari fissatubo

Abrazadera simple completa



Collier de fixation simple série légère complète
Simple clamp
Collare fissatubo singolo completo

DN	GRUPO GROUP	PACK MIN	REFERENCIA PART N°	€
6	1	10 uni	A40AZ06	1,68
8	1	10 uni	A40AZ08	1,68
10	1	10 uni	A40AZ10	1,68
12	1	10 uni	A40AZ12	1,68
1/4"	2	10 uni	A40AZ13.2	1,90
14	2	10 uni	A40AZ14	1,90
15	2	10 uni	A40AZ15	1,90
16	2	10 uni	A40AZ16	1,90
3/8"	2	10 uni	A40AZ16.7	1,90
18	2	10 uni	A40AZ18	1,90
19	3	10 uni	A40AZ19	2,12
20	3	10 uni	A40AZ20	2,12
1/2"	3	10 uni	A40AZ21.3	2,12
22	3	10 uni	A40AZ22	2,12
25	3	10 uni	A40AZ25	2,12
3/4"	4	10 uni	A40AZ26.7	2,27
28	4	10 uni	A40AZ28	2,27
30	4	10 uni	A40AZ30	2,27
32	5	10 uni	A40AZ32	2,85
1"	5	10 uni	A40AZ33.3	2,85
35	5	10 uni	A40AZ35	2,85
38	5	10 uni	A40AZ38	2,85
40	5	10 uni	A40AZ40	2,85
42	5	10 uni	A40AZ42	2,85
1 1/2"	6	10 uni	A40AZ48.3	4,25
50.8	6	10 uni	A40AZ50.8	4,25

Consultar plásticos en poliamida y aluminio // Plastique polyamide et aluminium, sur demande // Polyamide and aluminium plastics, on request // Plastica poliamide e alluminio, su richiesta

Plásticos polipropileno



Plastique polypropylene
Plastics polypropylene simple
Plastica polipropilene

DN	GRUPO GROUP	REFERENCIA PART N°	€
6	1	A106C	0,60
8	1	A108C	0,60
1/8"	1	A110.2C	0,60
10	1	A110C	0,60
12	1	A112C	0,60
1/4"	2	A213.2C	0,70
14	2	A214C	0,70
15	2	A215C	0,67
3/8"	2	A216.7C	0,70
16	2	A216C	0,70
18	2	A218C	0,70
19	3	A319C	0,88
20	3	A320C	0,88
1/2"	3	A321.3C	0,88
22	3	A322C	0,88
23	3	A323C	0,88
25	3	A325C	0,88
3/4"	4	A426.7C	0,96
28	4	A428C	0,96
30	4	A430C	0,96
1"	5	A533.3C	1,30
35	5	A535C	1,30
38	5	A538C	1,30
40	5	A540C	1,30
42	5	A542C	1,30
44.5	6	A644.5C	2,22
1 1/2"	6	A648.3C	2,22
50.8	6	A650.8C	2,22

Chapas inferiores



Plaques inferieurs à souder série légère
Lower plat simple
Piastre inferiori

GRUPO GROUP	REFERENCIA PART N°	€
1	APIN1	0,78
2	APIN2	0,84
3	APIN3	0,87
4	APIN4	0,90
5	APIN5	0,95
6	APIN6	1,40

Tornillos cabeza Allen



Vis tête six pans creux Allen
Simple Allen bolt
Vite Allen

GRUPO GROUP	REFERENCIA PART N°	€
1	AVTC1	0,17
2	AVTC2	0,20
3	AVTC3	0,21
4	AVTC4	0,22
5	AVTC5	0,34
6	AVTC6	0,39



Las abrazaderas completas se venden en bolsas de 10 unidades
Les collier de fixation complète sont vendus dans des sacs de 10 unités
The complete clamps are sold in bags of 10 units
Collare fissatubo completo sono venduti in sacchetti da 10 unità

Abrazaderas para tubo

Colliers de fixation
Clamps for pipe
Collari fissatubo

Abrazadera reforzada completa



Collier de fixation simple série légère renforcé complète
Reinforced clamp
Collare fissatubo rin forzato completo

DN	GRUPO GROUP	PACK MIN	REFERENCIA PART N°	€
6	1	10 uni	A41AZ06	1,91
8	1	10 uni	A41AZ08	1,91
10	1	10 uni	A41AZ10	1,91
1/8"	1	10 uni	A41AZ10.2	1,91
12	1	10 uni	A41AZ12	1,91
1/4"	2	10 uni	A41AZ13.2	2,14
14	2	10 uni	A41AZ14	2,14
15	2	10 uni	A41AZ15	2,14
16	2	10 uni	A41AZ16	2,14
3/8"	2	10 uni	A41AZ16.7	2,14
18	2	10 uni	A41AZ18	2,14
20	3	10 uni	A41AZ20	2,43
1/2"	3	10 uni	A41AZ21.3	2,43
22	3	10 uni	A41AZ22	2,43
25	3	10 uni	A41AZ25	2,43
3/4"	4	10 uni	A41AZ26.7	2,65
28	4	10 uni	A41AZ28	2,65
30	4	10 uni	A41AZ30	2,65
1"	5	10 uni	A41AZ33.3	3,18
35	5	10 uni	A41AZ35	3,18
38	5	10 uni	A41AZ38	3,18
40	5	10 uni	A41AZ40	3,18
42	5	10 uni	A41AZ42	3,18
44.5	6	10 uni	A41AZ44.5	4,69
1 1/2"	6	10 uni	A41AZ48.3	4,69
50.8	6	10 uni	A41AZ50.8	4,69

Consultar plásticos en poliamida y aluminio // Plastique polyamide et aluminium, sur demande // Polyamide and aluminium plastics, on request // Plastica poliamide e alluminio, su richiesta

Chapas superiores



Plaques superieurs de protection série légère
Upper plat reinforced
Piastre inferiori

GRUPO GROUP	REFERENCIA PART N°	€
1	APS1	0,27
2	APS2	0,29
3	APS3	0,33
4	APS4	0,38
5	APS5	0,44
6	APS6	0,55

Tornillos cabeza hexagonal



Vis hexagonale
Hexagonal bolt reinforced
Vite esagonale

GRUPO GROUP	REFERENCIA PART N°	€
1	AVTE1	0,15
2	AVTE2	0,17
3	AVTE3	0,20
4	AVTE4	0,22
5	AVTE5	0,28
6	AVTE6	0,34

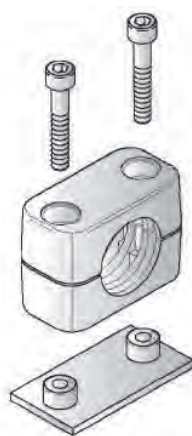

ABRAZADERA SIMPLE COMPLETA

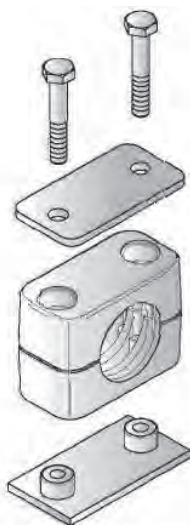

ABRAZADERA REFORZADA COMPLETA

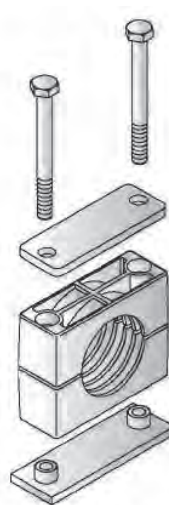

ABRAZADERA SERIE PESADA COMPLETA



ABRAZADERA DOBLE COMPLETA

Abrazaderas para tubo

Colliers de fixation
Clamps for pipe
Collari fissatubo

Abrazaderas dobles completas



Colliers de fixation doubles complètes
Double clamp - parallel
Collare fissatubo doppio completo

DN	GRUPO GROUP	PACK MIN	REFERENCIA PART N°	€
6	1	10 uni	AZCFS06	2,24
8	1	10 uni	AZCFS08	2,24
10	1	10 uni	AZCFS10	2,24
1/8"	1	10 uni	AZCFS10.2	2,24
12	1	10 uni	AZCFS12	2,24
1/8"	2	10 uni	AZCFS13.2	2,69
14	2	10 uni	AZCFS14	2,69
15	2	10 uni	AZCFS15	2,69
16	2	10 uni	AZCFS16	2,69
3/8"	2	10 uni	AZCFS16.7	2,69
18	2	10 uni	AZCFS18	2,69
19	3	10 uni	AZCFS19	3,07
20	3	10 uni	AZCFS20	3,07
1/2"	3	10 uni	AZCFS21.3	3,07
22	3	10 uni	AZCFS22	3,07
25	3	10 uni	AZCFS25	3,07
26	4	10 uni	AZCFS26	3,82
3/4"	4	10 uni	AZCFS26.7	3,82
28	4	10 uni	AZCFS28	3,82
30	4	10 uni	AZCFS30	3,82
33	5	10 uni	AZCFS33	5,79
1"	5	10 uni	AZCFS33.3	5,79
35	5	10 uni	AZCFS35	5,79
38	5	10 uni	AZCFS38	5,79
40	5	10 uni	AZCFS40	5,79
42	5	10 uni	AZCFS42	5,79
1"1/4	5	10 uni	AZCFS42.4	5,79

Consultar plásticos en poliamida // Plastique polyamide, sur demande // Polyamide plastics, on request // Plastica poliamide, su richiesta

Plásticos polipropileno



Plastiques polypropylene double
Plastics polypropylene double
Plastica polipropilene

DN	GRUPO GROUP	REFERENCIA PART N°	€
6	1	AD106C	0,80
8	1	AD108C	0,80
1/8"	1	AD110.2C	0,80
10	1	AD110C	0,80
12	1	AD112C	0,80
1/4"	2	AD213.2C	0,85
14	2	AD214C	0,85
15	2	AD215C	0,85
3/8"	2	AD216.7C	0,85
16	2	AD216C	0,85
18	2	AD218C	0,85
19	3	AD319C	1,05
20	3	AD320C	1,05
1/2"	3	AD321.3C	1,05
22	3	AD322C	1,05
25	3	AD325C	1,05
3/4"	4	AD426.7C	1,70
26	4	AD426C	1,70
28	4	AD428C	1,70
30	4	AD430C	1,70
1"	5	AD533.3C	2,70
33	5	AD533C	2,70
35	5	AD535C	2,70
38	5	AD538C	2,70
40	5	AD540C	2,70
1"1/4	5	AD542.4C	2,70
42	5	AD542C	2,70

Chapas superiores



Plaques superieurs de protection double
Upper plat double
Piastra superiori

GRUPO GROUP	REFERENCIA PART N°	€
1	ADPS1	0,39
2	ADPS2	0,50
3	ADPS3	0,53
4	ADPS4	0,56
5	ADPS5	0,69

Chapas inferiores



Plaques inferieurs à souder double
Lower plat double
Piastra inferiori

GRUPO GROUP	REFERENCIA PART N°	€
1	ADPIN1	0,95
2	ADPIN2	0,95
3	ADPIN3	1,29
4	ADPIN4	1,51
5	ADPIN5	1,73

Tornillos cabeza hexagonal



Vis hexagonale
Hexagonal bolt double
Vite esagonale

GRUPO GROUP	REFERENCIA PART N°	€
1	ADVTE1	0,17
2	ADVTE2	0,22
3	ADVTE3	0,25
4	ADVTE4	0,29
5	ADVTE5	0,39

Abrazaderas para tubo

Colliers de fixation
Clamps for pipe
Collari fissatubo

Pipe

DIN 2353 Pipe Fittings

Gas tube fittings

JIC 37° fittings

SAE Flanges

Clamps

Machines for processing rigid pipes

Plásticos polipropileno



Plastique polypropylene
Plastics polypropylene heavy
Plastica polipropilene

DN	GRUPO GROUP	REFERENCIA PART N°	€
6	1	AMPP106C	1,60
8	1	AMPP108C	1,60
10	1	AMPP110C	1,60
12	1	AMPP112C	1,60
1/4"	1	AMPP113.2C	1,60
14	1	AMPP114C	1,60
15	1	AMPP115C	1,60
16	1	AMPP116C	1,60
18	1	AMPP118C	1,60
20	1	AMPP120C	1,60
20	2	AMPP220C	2,11
1/2"	2	AMPP221.3C	2,11
22	2	AMPP222C	2,11
25	2	AMPP225C	2,11
3/4"	2	AMPP226.7C	2,11
28	2	AMPP228C	2,11
30	2	AMPP230C	2,11
30	3	AMPP330C	3,00
32	3	AMPP332C	3,00
1"	3	AMPP333.3C	3,00
35	3	AMPP335C	3,00
38	3	AMPP338C	3,00
40	3	AMPP340C	3,00
1"1/4	3	AMPP342.4C	3,00
42	3	AMPP342C	3,00
45	3	AMPP345C	3,00
38	4	AMPP438C	6,07
40	4	AMPP440C	6,07
1"1/4	4	AMPP442.4C	6,07
42	4	AMPP442C	6,07
45	4	AMPP445C	6,07
1"1/4	4	AMPP448.4C	6,07
48	4	AMPP448C	6,07
50	4	AMPP450C	6,07
55	4	AMPP455C	6,07
2"	4	AMPP460.3C	6,07
60	4	AMPP460C	6,07
65	4	AMPP465C	6,07
70	4	AMPP470C	6,07

Tornillos cabeza hexagonal



Vis hexagonale
Hexagonal bolt heavy
Vite esagonale

GRUPO GROUP	REFERENCIA PART N°	€
1	AVTEP1	0,56
2	AVTEP2	0,67
3	AVTEP3	0,78
4	AVTEP4	1,34

Chapas inferiores



Plaques inferieurs à souder série lourde
Lower plat heavy
Piastra inferiori

GRUPO GROUP	REFERENCIA PART N°	€
1	APINP1	2,49
2	APINP2	2,81
3	APINP3	3,19
4	APINP4	7,67

Chapas superiores



Plaques superieurs de protection série lourde
Upper plat heavy
Piastra superiori

GRUPO GROUP	REFERENCIA PART N°	€
1	APSP1	1,02
2	APSP2	1,15
3	APSP3	1,28
4	APSP4	2,87

Abrazaderas para tubo

Colliers de fixation
Clamps for pipe
Collari fissatubo

Chapa agrupar abrazaderas simples



Plaque à joindre pour collier simple
Jointed plate for simple clamp
Piastra gruppo per collare fissatubo singolo

R. T.	Descripción Description	G. G.	REFERENCIA PART N°	€
-	Chapa agrupar (simples)	1	APAG1	7,55
-	Chapa agrupar (simples)	2	APAG2	7,72
-	Chapa agrupar (simples)	3	APAG3	11,75

Chapa agrupar abrazaderas dobles



Plaque à joindre pour collier double
Jointed plate for double clamp
Piastra gruppo per collare fissatubo doppio

R. T.	Descripción Description	GRUPO GROUP	REFERENCIA PART N°	€
-	Chapa agrupar (dobles)	1	ADPAG1	5,09
-	Chapa agrupar (dobles)	2	ADPAG2	6,26
-	Chapa agrupar (dobles)	3	ADPAG3	6,43

Tornillo apilar ligera



Vis pour empiler serie légère
Light serie screw to pile up
Vite per piastra componibili. Serie leggera

GRUPO GROUP	REFERENCIA PART N°	€
1	AVTA1	1,23
2	AVTA2	1,29
3	AVTA3	1,45
4	AVTA4	1,51
5	AVTA5	1,54

Chapa apilar ligera



Plaque pour empiler serie légère
Light serie plate to pile up
Piastra componibili. Serie leggera

GRUPO GROUP	REFERENCIA PART N°	€
1	APA1	0,34
2	APA2	0,39
3	APA3	0,48
4	APA4	0,56
5	APA5	0,59

Accesorios carril



Accessories pour lane
Accessories for lane
Accessori per lane

R. T.	Descripción Description	G. G.	REFERENCIA PART N°	€
-	Carril guía (Simples/Dobles)	-	TS14A	7,13

Chapa atornillar Abr. Simples



Plaque à visser
Elongated weld plate
Piastra per fissaggio

GRUPO GROUP	REFERENCIA PART N°	€
1	APT1	0,78
2	APT2	0,81
3	APT3	0,84
4	APT4	0,90
5	APT5	1,12

Tornillo apilar doble



Vis pour empiler serie double
Double serie screw to pile up
Vite per piastra componibili. Serie doppia

GRUPO GROUP	REFERENCIA PART N°	€
2	ADVTA2	1,90
3	ADVTA3	2,07
4	ADVTA4	2,42

Chapa apilar doble



Plaque pour empiler serie double
Double serie plate to pile up
Vite per piastra componibili. Serie doppia

GRUPO GROUP	REFERENCIA PART N°	€
1	ADPA1	0,34
2	ADPA2	0,34
3	ADPA3	0,34
4	ADPA4	0,34

Abrazaderas para tubo

Colliers de fixation | Clamps for pipe | Collari fissatubo

Pipe

DIN 2353 Pipe Fittings

Gas tube fittings

JIC 37° fittings

SAE Flanges

Clamps

Machines for processing rigid pipes

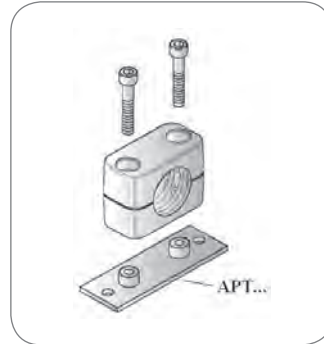
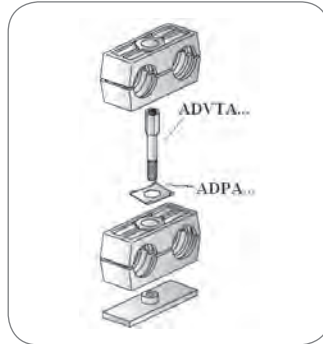
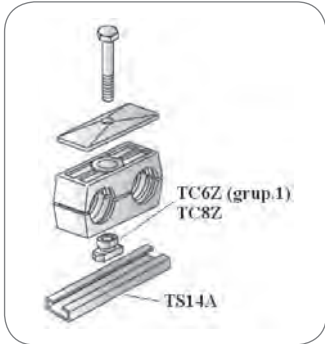
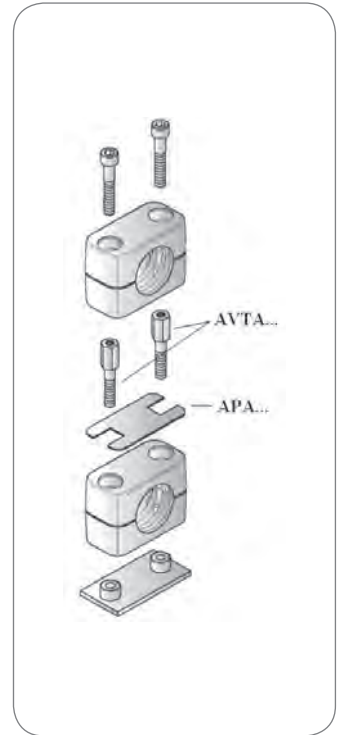
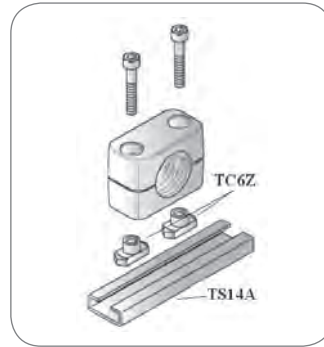
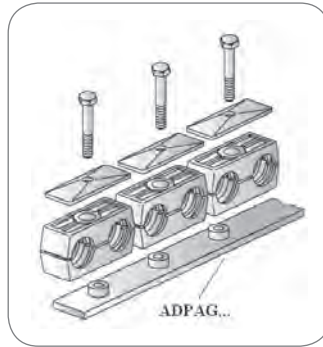
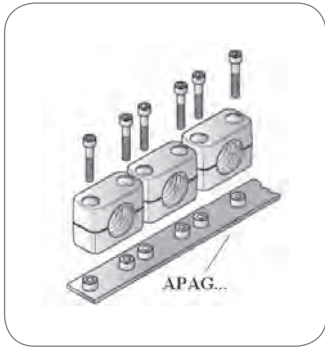

► **Artículos bajo consulta** | Articles à consulter | Items on request | Articoli su richiesta

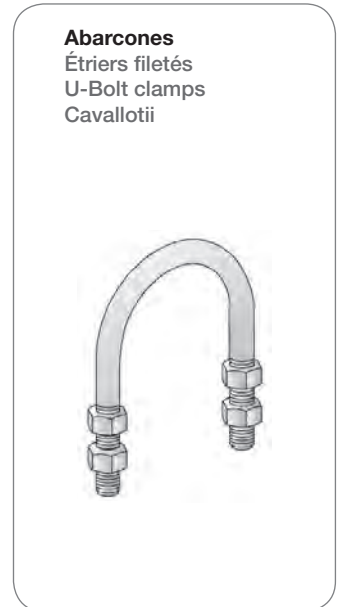
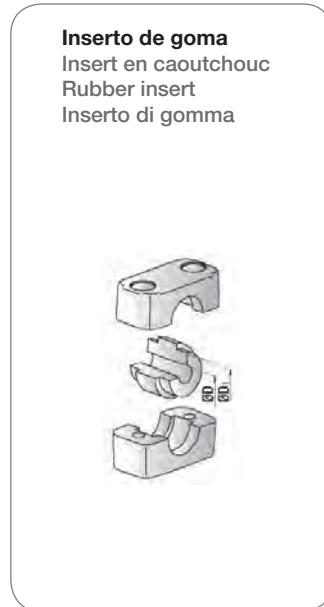
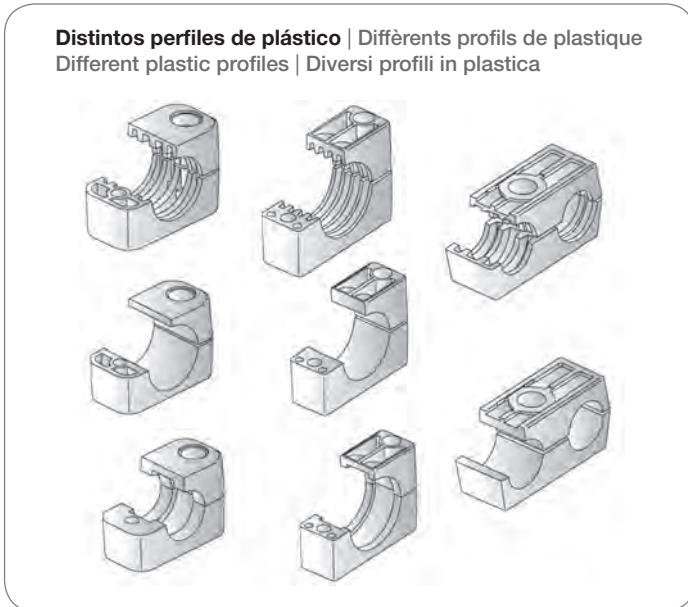

Abrazaderas para tubo

Colliers de fixation | Clamps for pipe | Collari fissatubo

Bolsa de 10 unidades completas sin montar | Sacs de 10 unités complètes non montés
Bags of 10 complete units unassembled | Borse di 10 unità complete non montate



Pipe

DIN 2353 Pipe Fittings

Gas tube fittings

JIC 37° fittings

SAE Flanges

Clamps

Machines for processing rigid pipes

7

Maquinaria para tubo rígido

Machines pour le tube rigide | Machines for rigid tube | Macchine per il tubo rigido

Pipe

DIN 2353 Pipe Fittings

Gas tube fittings

JIC 37° fittings

SAE Flanges

Clamps

Machines for processing rigid pipes

Dobladoras | Cintreuse | Bending machine | Curvatubi

C-42
Dobladora accionamiento hidráulico | Hydraulic bending machine



Tubo Pipe	6 → 42 x 4 mm
Potencia Power	2"

CMS-42
Dobladora accionamiento manual hidráulico | Manual bending machine with hydraulic operation



Tubo Pipe	6 → 42 x 4 mm
-------------	---------------

M18 6-18
Dobladora manual | Manual bending machine



Tubo Pipe	6 → 18 mm
-------------	-----------

Radios de curvatura | Rayon de courbure | Bending radius | Raggi di curvatura

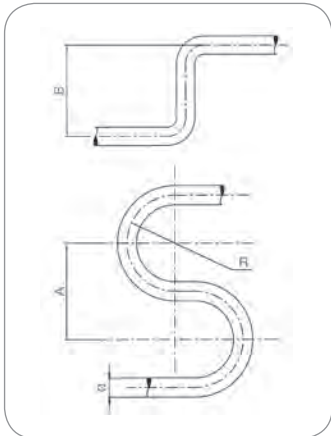

Matrices de doblado | Bending tools



Tubo Ø Tube Ø	Radio de curvatura Bending radius (mm)	Máx. ángulo de curvatura Max. bending angle	A (mm)	B (mm)
6	15	170°	60	70
8	16.5	170°	60	70
10	27.5	170°	70	115
12	32.7	170°	80	120
14	46	170°	110	180
15	46	170°	110	180
16	48	170°	110	180
18	48	170°	110	190
20	66	160°	140	230
22	66	160°	140	240
25	81.5	160°	170	270
28	81	160°	180	300
30	98.5	150°	220	300
32	101	150°	220	300
35	125.5	120°	250	440
38	116	120°	250	440
42	126	120°	250	440
1/8"	27.5	170°	70	115
1/4"	46	170°	110	180
3/8"	48	170°	110	180
1/2"	66	160°	140	240
3/4"	81	160°	180	300
1"	125.5	120°	250	440
1 1/4"	126	120°	250	440

Desbarbadora | Machine a ebavurer | Deburring machine | Sbavatore

S01



Desbarbado exterior External deburring	6 → 42 mm
Desbarbado interior Internal deburring	6 → 42 mm
Potencia motor Engine power	0,18 KW
R.P.M. R.P.M.	75

Útiles desbarbado incluidos | Deburring tools included



Otras máquinas: consultar | Autres machines, sur demande | Other machines, on request | Altre macchine, sur richiesta



Maquinaria para tubo rígido

Machines pour le tube rigide | Machines for rigid tube | Macchine per il tubo rigido

Montaje racores DIN 2353 y JIC 37° | Montage du raccord DIN 2353 et JIC 37° | DIN 2353 and JIC 37° pipe fittings assembly | Assemblaggio del raccordo ad anello DIN 2353 e JIC 37°

USFL015MAN Montaje manual | Manual assembly

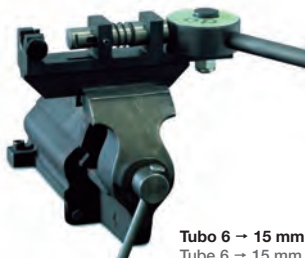

Tubo 6 → 15 mm
Tube 6 → 15 mm



USFL/01 MAN Accionamiento manual hidráulico | Manual device with hydraulic operation



USFL/01 Accionamiento hidráulico | Hydraulic device



	US-FL/01	US-FL/01 MAN	
Premontaje DIN 2353 24° Preassembling DIN 2353 24°	6 → 42 x 4 mm	6 → 42 x 4 mm	
Abocardado JIC 37° 37° JIC Flaring	6 → 42 x 4 mm	6 → 42 x 4 mm	Con BL
Potencia motor Engine power	0,75 KW		

Matrices | Tools

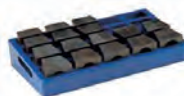

Bloque BL JIC 37° | BL Block JIC 37°



Machos | Males



Portaherramientas opcional
Tool handler optional

Centro de trabajo | Unité multifonctionnelle | Multi-functional unit | Unità multifunzione

	Mini Mini	Completo Complete
Premontaje DIN 2353 24° Pre-assembling	6 → 42 x 4 mm	6 → 42 x 4 mm
Abocardado JIC 27° 37° Flaring	6 → 42 x 4 mm	6 → 42 x 4 mm
Corte Cutting	-	Máx. ø 100 mm
Curvatura Bending	6 → 42 x 4 mm	6 → 42 x 4 mm
Desbarbado Deburring	Máx. ø 42 x 4 mm	Máx. ø 42 x 4 mm
Potencia motor Engine power	1,7 KW máx.	4,6 KW máx.
Compresor Compressed air	-	200 L/MIN

Completo | Complete



Mini | Mini



Machos | Males



Matrices | Tools

